

Operating instruction

eTower 200

Payment Terminal; SAM inter; CMS

Article Number: i00022271





The power to move

Table of contents

1	About this manual	7
1.1	Further requirements	7
1.2	Conventions of presentation	8
1.3	Abbreviations	9
1.4	Locations and contact information	10
2	Safety	11
2.1	Warnings	11
2.1.1	Sectional warnings	11
2.2	Intended use	12
2.3	Foreseeable misuse	12
2.4	Safety instructions for the user	12
2.5	Personnel qualification	13
2.6	Dangers and residual risks	13
2.6.1	Electrical voltage	13
2.6.2	Incorrect handling	14
3	Product description	15
3.1	Public key	15
3.2	Design	15
3.3	Series label	17
3.4	Technical specifications	18
3.4.1	General information	18
3.4.2	Connections	18
3.4.3	Electrical characteristics	19
3.4.4	Protective devices	19
3.4.5	Ambient conditions	19
3.4.6	Mechanical data	20
3.4.7	Communication interfaces	20
3.4.8	Legal regulations	21
4	Transport, packaging and storage	22
4.1	Transport Inspection	22
4.2	Storage conditions	22
4.3	Transport	23
5	Installation	24
5.1	Installation work	24
5.2	Notes on mechanical installation	24
5.3	Notes on electrical installation	25
5.4	Location	25

5.5	Base mounted	27
5.6	Installation on concrete base	29
5.7	Cable gland	31
5.8	Installation of the charging system	34
5.8.1	Lifting via roof attachment points	34
5.8.2	Lifting with a forklift	35
5.8.3	Placing charging system on connection bracket	35
5.9	Folding out the ventilation and removing the protective cover	36
5.10	Connecting the supply cable	37
5.11	Equipotential bonding	38
5.12	Data connection via RJ45 plug	39
5.13	Cable management system	40
5.13.1	Preparing for installation	40
5.13.2	Mounting the KMS	41
5.13.3	Position the antennas	43
5.13.4	Mounting the charging cable shell	44
6	Start-up	45
6.1	System start-up	46
7	DUCTO web interface	47
7.1	Configuration of the charging system with DUCTO	47
7.2	Creating a network connection	47
7.3	Calling up the configuration interface	48
7.4	Login	49
7.4.1	Selecting the language	49
7.4.2	Operator login	50
7.4.3	Logging in as qualified electrician	51
7.5	Design of DUCTO	51
7.6	Dashboard	52
7.7	Settings	52
7.7.1	Parameter selection	54
7.7.2	Changing parameters	55
7.7.3	Charging station	55
7.7.4	Currents	55
7.7.5	Network	56
7.7.6	Backend	60
7.7.7	Payment	60
7.7.8	Offline operation	61
7.7.9	Charge management	62
7.8	Charging data	64
7.8.1	Exporting charging data	65
7.9	RFID list	65
7.9.1	Teach-in mode	65

7.9.2	Adding an entry	65
7.9.3	Groups	66
7.10	Save & restore	66
7.10.1	Save	67
7.10.2	Restore	68
7.10.3	Resetting to factory settings.....	69
7.11	Firmware update	69
7.11.1	Performing a firmware update	69
7.12	Reading out log data	70
7.13	Changing the password	70
7.14	Parameter list	71
7.15	Restart	71
7.16	Troubleshooting information	72
7.17	DUCTO Guide	72
8	Operation.....	73
8.1	Charging process	74
8.1.1	Overview of the charging system	74
8.1.2	Meaning of the status LED colours	75
8.1.3	Acoustic signals.....	75
8.1.4	Authorisation options	76
8.1.5	Connecting the charging cable	79
8.1.6	Starting the charging process.....	80
8.1.7	Ending the charging process	81
9	Malfunctions	83
9.1	Internal errors	83
9.2	Residual current circuit breaker (RCCB).....	83
9.3	Circuit breaker (MCB)	83
10	Troubleshooting information.....	84
10.1	About this information.....	84
10.2	Scope of application	84
10.3	OCPP 1.6	84
10.4	Compleo-specific.....	85
11	Maintenance	88
11.1	Maintenance plan	89
11.2	Replacing the filter mat at the air inlet.....	90
11.3	Replacing the filter mat at the air outlet	90
11.4	Cleaning.....	91
12	Decommissioning, dismantling and disposal	92
12.1	Disposal	92

13 Annexes.....	94
13.1 Unit dimensions	94
13.2 Data sheets for V-steel frame clamps	95
13.2.1 V-steel frame clamps.....	96
13.3 Commissioning and test reports.....	100
13.3.1 DC-Prüfprotokoll_V1.9.....	101
13.4 Declarations of conformity	106
13.4.1 i00022104_Vereinfachte DoC_rev02_EUSp.....	107
13.5 Memory and display module SAM.....	109
13.5.1 BA SAM_Inter_Rev06_DE.....	110

1 About this manual

This manual contains descriptions and important information for the safe and trouble-free use of the charging system.

The manual is part of the charging system and must be accessible at all times to all persons working on and with the charging system. The manual must be kept in a clearly legible condition.

The personnel must have carefully read and understood this manual before starting any work. The basic prerequisite for safe working is the observance of all specified safety and warning instructions as well as handling instructions in this manual.

In addition to the instructions in this manual, the local accident prevention regulations and the national industrial safety regulations apply.

Illustrations are for basic understanding and may differ from the actual design of the charging system.

Additional information on the product: <https://www.compleo-charging.com/produkte/document-center>.

1.1 Further requirements

A warranty with regard to function and safety is only given if this manual is observed. Compleo Charging Solutions AG is not liable for personal injury or damage to property caused by failure to observe the operating instructions.

The manufacturer of the charging system is not liable for consequential damage.

The operator must ensure that the product is properly installed and used as intended.

During installation and start-up, the national legal requirements and regulations for accident prevention must be observed. In Germany these include the requirements according to DIN VDE 0100 and the accident prevention regulations according to DGUV V3.

Before the product is released, an appropriate test must be carried out to safeguard all safety features and proper functionality of the product. In addition, the operator must ensure the operational safety of the product by means of regular maintenance (see chapter *11 Maintenance, page 88*).

This document reflects the state-of-the-art of the product at the time of publication.

Compleo Charging Solutions GmbH assumes no liability for errors within this manual. The contents of this document are for information purposes only and are not the subject of a contract.



NOTICE

Compliance with regulations

The normative references and regulations according to which the product was designed and constructed are listed in the declaration of conformity. When installing and commissioning a product from Compleo Charging Solutions, nationally applicable standards and regulations must also be observed.



INFORMATION

Validity of standards and regulations

All standards, regulations, inspection intervals and the like mentioned in this document are valid in Germany. If a system is set up in another country, equivalent documents with a national reference must be used.

1.2 Conventions of presentation

For easy and quick understanding, different information in this manual is presented or highlighted as follows:

- List without fixed order
- List (next item)
 - Subitem
 - Subitem
- 1. Handling instruction (step) 1
- 2. Handling instruction (step) 2
 - ⇒ Additional notes for the previous step

(1) Position number in figures and keys

(2) Consecutive position number

(3)...

Reference (example): See "chapter 6.5, page 27"





INFORMATION

Information contains application tips, but no hazard warnings.

1.3 Abbreviations

Abbreviation	Explanation
AC	Alternating Current
BM	Floor mounting on prefabricated base or load-bearing ground
CCS	Combined Charging System
CHA	Abbreviation for plug designation: CHAdeMO
CPO	Charge Point Operator
DC	Direct Current
eHZ	electronic domestic meter
EKA	Billing in compliance with calibration law
EMC	Electromagnetic Compatibility
fleet	Charging station with busbar system
HAK	Domestic junction box
IMD	Insulation Monitoring Device IEC 61557-8
IMS	Intelligent measuring system
CMS	Cable management system
MCB	Miniature Circuit Breaker
MessEG	Measuring and calibration law
MessEV	Measuring and calibration regulations
N/A	Not Available/ Applicable
OCPP	Open Charge Point Protocol
PT	Payment Terminal
RCD	Residual Current Device
RDC-DD	Residual Direct Current-Detecting Device
S/N	Serial number
SAM	Memory and display module
SPD	Surge Protective Devices
SVHC	Substances of Very High Concern
UV	Sub-distribution
WLL	Work Load Limit

1.4 Locations and contact information

 Compleo Charging Solutions GmbH & Co. KG Ezzestraße 8 44379 Dortmund, Germany	+49 231 53492370 info@compleo-cs.com compleo-charging.com
 Compleo Charging Solutions UK Ltd. The Lambourn, Wyndyke Furlong Abingdon, OX14 1UJ, United Kingdom	+44 1235 355189 hello.uk@compleo-cs.com compleocharging.co.uk
 Compleo Charging Solutions AG Switzerland Hardturmstrasse 161 8005 Zurich, Switzerland	info.ch@compleo-cs.com compleo-charging.ch
 Compleo Charging Solutions GmbH Speisinger Straße 25/12 1130 Vienna, Austria	infoAT@compleo-cs.com compleo.at
 Compleo CS Nordic AB Derbyvägen 4 212 35 Malmö, Sweden	+46 40 6850500 info.sweden@compleo-cs.com compleocs.se

2 Safety

To ensure operational safety of the charging equipment and to avoid serious injuries caused by flashovers or short circuits, the following information and safety instructions for operating the unit must be observed.

Repair work on the unit must only be carried out by authorised specialist personnel. The housing of the unit may only be opened by persons who have been properly instructed.

The following points always apply:

- Read and observe safety and warning instructions
- Read and follow instructions

2.1 Warnings

In this manual, warnings and notes are presented as follows.



DANGER

Indicates an imminent danger that will result in death or serious injury if not avoided. There is great danger to life.



WARNING

Indicates a potentially hazardous situation which could result in death or serious injury if not avoided.



CAUTION

Indicates a potentially hazardous situation which may result in minor or moderate injury if not avoided.



NOTICE

Indicates a potentially hazardous situation which may lead to material damage if not avoided.

2.1.1 Sectional warnings

Sectional warnings refer to entire chapters, a section or several paragraphs within this manual.

Sectional warnings are presented as follows (example warning):



⚠ WARNING

Type and source of the danger

Possible consequences if the danger is ignored.

- Measures to avoid the danger.

2.2 Intended use

The charging system is intended exclusively for charging electric vehicles.

The charging system is suitable for public and semi-public areas and can be used indoors and outdoors.

The charging system is intended exclusively for stationary installation.

Any use beyond this is considered improper use. The manufacturer is not liable for damages resulting from this.

2.3 Foreseeable misuse

The use of the charging system as a power source for other power consumers is not in accordance with its intended use and is considered misuse.

Only type 2/ 20 A or type 2/ 32 A charging cables that comply with the product standard IEC 62196-2:2016; EN 62196-2:2017 may be used on charging systems equipped with a type 2 charging socket. Charging cables that deviate from the above are not accepted by the systems.

Charging systems may only be connected to the power supply via a fixed and non-separable supply line.

2.4 Safety instructions for the user

This charging system may only be used in the manner described in this manual. If the charging system is used for other purposes, the operator may be endangered and the charging equipment may be damaged. This manual must always be accessible. Note the following points:

- If no charging process is active, anchor any existing charging cables on the charging system in the brackets provided or wrap them around the housing of the charging system.
- The charging system may only be operated when completely closed. Do not remove covers inside the charging system.

2.5 Personnel qualification

Qualified and trained electricians meet the following requirements:

- Knowledge of general and special safety and accident prevention regulations.
- Knowledge of the relevant electrotechnical regulations.
- Product-specific knowledge through appropriate training.
- Ability to identify hazards associated with electricity.



DANGER

Danger due to electric current

Touching live parts will result in electric shock with serious injury or death.

- Work on electrical components may only be carried out by a qualified electrician and in accordance with electrotechnical regulations.
- Ensure absence of voltage and take suitable protective measures.

2.6 Dangers and residual risks



NOTICE

Compleo charging systems as a whole do not contain SVHCs (Substances of Very High Concern) in a concentration of more than 0.1 % (w/w), related to the individual charging station. However, individual components may contain SVHCs in concentrations > 0.1 % (w/w).

- When the charging stations are used as intended, no SVHCs are released and there are no risks to humans or the environment.

2.6.1 Electrical voltage

Dangerous electrical voltages may be present inside the housing of the charging system after the housing has been opened. There is a danger to life if contact is made with live components. Serious injury or death is the result.

- Work on electrical equipment may only be carried out by a qualified electrician and in accordance with electrical engineering rules.
- Disconnect the charging system from the power supply.

2.6.2 Incorrect handling

- Pulling on the charging cable can lead to cable breakage and damage. Only pull the charging cable out of the socket directly at the plug.
- The use of extension cables is not permitted. To avoid the risk of electric shock or cable fire, only one charging cable may be used at a time to connect the electric vehicle and charging system.
- A charging system whose charging cables are in contact with the ground involves a risk of tripping or mechanical damage if run over. The operator of the charging system must implement appropriate measures for cable routing and affix appropriate warnings.



WARNING

Risk of electric shock and fire due to the use of adapters

Using adapters on the charging cable can cause serious injury and damage to property.

- Do not use any adapters on the charging cable.

3 Product description

The charging system described below eTower200 SAM PT, mounted on solid ground or base, is designed for charging electric vehicles indoors and outdoors.

Instructions, states and messages are indicated by means of status LEDs and/or displays.

The charging system has two charging points where parallel charging is possible.

3.1 Public key

The public key is a character string with which the charging point can be uniquely identified and is shown as a QR code on the SAM display associated with the charging point.



INFORMATION

The public key can also be shown on billing documents, e.g. on the customer receipt for card-based ad hoc charging processes.

The display on the station is mandatory.

3.2 Design



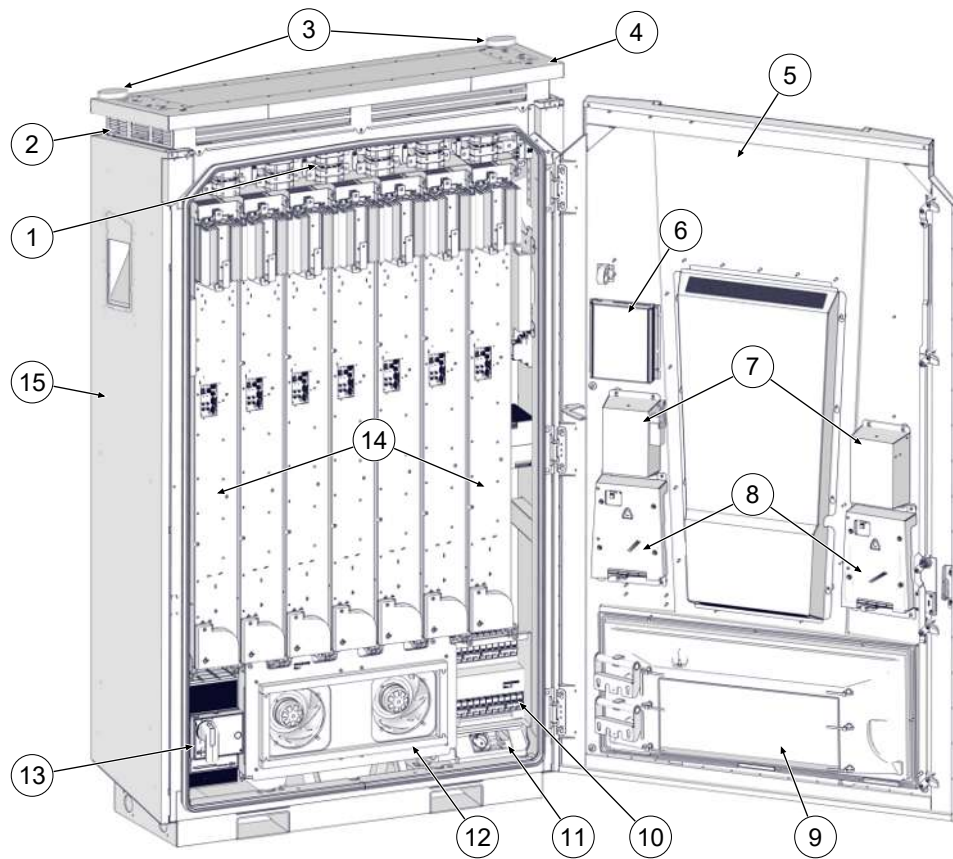

- (1) Switching matrix
- (2) Air outlet
- (3) Antennas
- (4) Roof
- (5) Cabinet door
- (6) Controller
- (7) Parking positions for charging plugs
- (8) Memory and display module (SAM)
- (9) Air inlet filter box
- (10) Fuses
- (11) Service socket
- (12) Main fan
- (13) Main switch
- (14) LE modules (7 units)
- (15) Cabinet

3.3 Series label

A series label is attached to each charging point on the charging system. The following figure shows an example of the arrangement of information on a serial label:

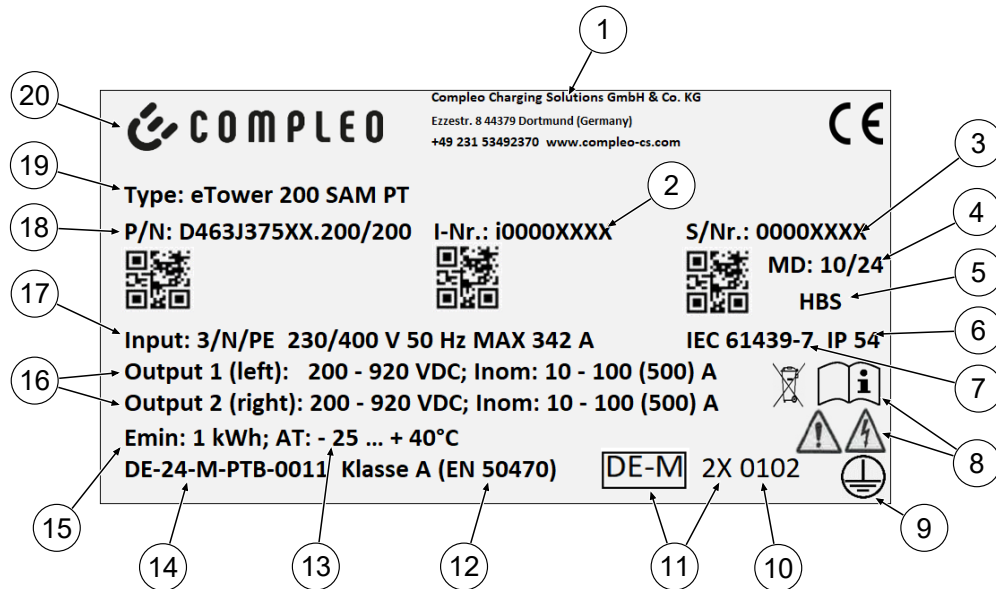

The serial label can be used to identify the following information:

- (1) Company name
- (2) Article number
- (3) Serial number
- (4) Calendar week and year of manufacture
- (5) Place of manufacture
- (6) Protection type
- (7) Production standard
- (8) Pictograms (safety, operating manual, disposal)
- (9) Protection class
- (10) Conformity assessment body
- (11) Metrology marking
- (12) Accuracy class of the measuring instrument according to EN 50470
- (13) Ambient temperature
- (14) Number of the type examination certificate
- (15) Minimum energy import (compliant with calibration law)
- (16) Output 1: Voltage range, frequency, min. current, max. current (analog output 2)
- (17) Input: Number of phases, voltage, frequency, max. input current
- (18) Material number
- (19) Type designation of the charging system
- (20) Manufacturer

3.4 Technical specifications

3.4.1 General information

Charging system	eTower200 SAM PT
Article number	i00022267
Charging standard	Mode 4

3.4.2 Connections

Mains connection	5-pin connection bracket
Max. connection cross-section ¹⁾	according to accessory package
Max. equipotential bonding	Round wire V4A: Ø 10 mm; H07V-K: 35 mm ² with M8 compression cable lug

1) = Connection variants

Version	Designation	Equipment	Max. cross-section
1	Accessory package 1	V-terminals	240 mm ²
2	Accessory package 2	Double V-terminals	2 x 120 mm ²
3	Customised performance	Compression cable lug M10	according to specifications



INFORMATION

Compleo recommends the use of copper cable for the mains connection. When using aluminium ladders, the manufacturer's specifications must be observed. See chapter 13.2 *Data sheets for V-steel frame clamps*, page 95.

Ethernet	RJ45 socket
Min. connection cross-section	26 AWG
Max. length	30 m

3.4.3 Electrical characteristics

Mains voltage	400 V/ 3~
Max. rated current	342 A/ 3~
Network form	TN
Protection class	I
Overvoltage category	III
Mains frequency	50 Hz
Charging voltage	200 - 920 V
Max. charging current	500 A
Max. charging capacity/ charging point	200 kW
Rated short-time withstand current (I _{cw})	20 kA
Max. pre-fuse	400 A gG/gL

3.4.4 Protective devices

RCD	2 x Insulation Monitoring Device (IMD), switching limit: 100 Ohm/ Volt
MCCB	7 x B63A, 1 x B10A
SPD	ÜS 1/2/3 - DIN EN 61643-11

3.4.5 Ambient conditions

Ambient temperature	-25 °C to +40 °C
Operating temperature (Ø 24 h)	≤ 35 °C
Storage temperature	-25 °C to +50 °C
Relative humidity	≤ 95 % (non-condensing)
Altitude	≤ 2000 m above sea level

3.4.6 Mechanical data

Dimensions (H x W x D)	2000 x 1200 x 450 mm
Max. weight	750 kg
Housing	Steel
Housing closure	Pivoted lever mechanism for locking cylinder
Impact resistance level	IK10
Protection type	IP54
Degree of contamination	3
Type/mounting	Ground or base mounting

3.4.7 Communication interfaces

Data communication	TCP/IP
Data connection modem 1 <i>(frequency/transmission power)</i>	Ethernet, LTE <i>(800 MHz, 900 MHz, 1800 MHz, 2100 MHz, 2600 MHz/ 23.0 ±1 dBm)</i>
Data connection modem 2 <i>(frequency/transmission power)</i>	2G (900 MHz, 1800 MHz; @33 dBm) 4G (700 MHz, 800 MHz, 900 MHz, 1800 MHz, 2100 MHz; @ 23 dBm)
Backend communication	OCPP: 1.6J, 2.0-ready
RFID standard <i>(frequency/transmission power)</i>	Payment terminal <i>(13.56 MHz/ < 1 W, < 30 dBm)</i>

3.4.8 Legal regulations

2014/53/EU (Radio Equipment Directive)

2011/65/EU (RoHS Directive)

2001/95/EG (Directive on General Product Safety)

2012/19/EU (WEEE Directive)

(EU) 2019/1021 (EU-POP Ordinance)

(EU) 1907/2006 (REACH Regulation)

SVHC	EU no.	CAS no.
Lead (Pb)	231-100-4	7439-92-1
4,4' isopropylidendiphenol (bisphenol A; BPA)	201-245-8	80-05-7
Lead(II) oxide (PbO)	215-267-0	1317-36-8
N,N-dimethylacetamide	204-826-4	127-19-5
Diboron trioxide	215-125-8	1303-86-2
N,N-dimethylformamide	200-679-5	68-12-2
Dodecamethylcyclohexasiloxan (D6)	208-762-8	540-97-6
Decamethylcyclopentasiloxan (D5)	208-764-9	541-02-6
Octamethylcyclotetrasiloxan (D4)	209-136-7	556-67-2
Lead titanium zirconium oxide	235-727-4	12626-81-2
Lead titanium trioxide	235-038-9	12060-00-3

4 Transport, packaging and storage

4.1 Transport Inspection

Depending on the type and scope of the product, it is delivered either upright or horizontally in appropriate transport and protective packaging.

Air-cushioned protective films and/or cardboard packaging are used. These materials can also be used as underlay during subsequent assembly.

1. After unpacking, thoroughly inspect the product for transport damage.
2. Compare the serial number of the product with that of the delivery documents to exclude faulty deliveries.
3. Check delivery according to purchase and scope of delivery for completeness.
4. Proceed as follows in case of deviations or recognisable damages:
 - Do not accept delivery or only accept it conditionally.
 - Complaints must be reported immediately to the manufacturer in writing.



NOTICE

We recommend keeping and reusing the original packaging for further transportation. Otherwise, the packaging material must be disposed of in accordance with the applicable local regulations.



INFORMATION

Do not tilt or place the loading system on its side.

4.2 Storage conditions

The system should be stored in the same position that it was transported in. If this is not possible for undetermined reasons, it should be stored in the installation position of the product.

- Ambient temperature for storage: -25 °C to +50 °C
- Permissible relative humidity: maximum 95 % (non-condensing)
- For intermediate storage, store the product in its original packaging

4.3 Transport

The charging system can be transported with lifting gear or a forklift. (see chapter 5.8 *Installation of the charging system, page 34*).



INFORMATION

Transport with lifting gear is strongly recommended.



WARNING

Suspended loads

Falling loads can cause serious injury or death.

- Never step under suspended loads.
- Attach slings only to the designated attachment points.
- Only use approved lifting gear and slings in perfect condition with sufficient load capacity.
- Transport the load close to the ground and set it down immediately after transport to its destination.

5 Installation

5.1 Installation work

The assembly and installation work requires specific technical qualifications and expertise. There is a danger to life for persons who carry out work for which they have neither been qualified nor instructed. The work may only be carried out by persons who are familiar with it, have been informed about dangers and have the necessary qualifications.

Observe the national legal requirements and regulations during assembly and installation.



NOTICE

Unit damage due to environmental influences

Environmental influences due to rain, splash water or heavy dust exposure on exposed installation components without an installation cover cause damage to the unit.

- Do not leave the charging system unattended with the installation cover open.



INFORMATION

The installation and commissioning of the charging station with payment terminal can lead to moisture forming in the displays under certain weather conditions, such as high humidity and cold.

This accumulation of moisture will evaporate completely in up to 48 hours after the station has been put into operation. The function is not affected.

5.2 Notes on mechanical installation



WARNING

Incorrect installation and start-up

Improper performance of work can lead to serious injuries and damage to property.

- Only allow work to be carried out by trained specialist personnel.
- Before installation, fulfil all safety-related conditions.
- Carry out mechanical installation only when the system is in a de-energised state.

- Provide sufficient free space for the installation.

The installation site must be sufficiently accessible so that the charging system can be installed and serviced without interference.

- Use a suitable material and tool for installation.



INFORMATION

The use of specific installation materials for the charging system may be necessary depending on the condition of the ground or special local conditions. The necessity must be considered individually at each location.

The following description of installation with specific installation material is exemplary. Local conditions are not dealt with in detail. Deviating procedures may only be initiated by competent persons.

5.3 Notes on electrical installation



DANGER

Danger due to electric current

Touching live parts will result in electric shock with serious injury or death.

- Work on electrical components may only be carried out by a qualified electrician and in accordance with electrotechnical regulations.
- Ensure absence of voltage and take suitable protective measures.

- For safe disconnection during installation work, disconnect the charging system from the power supply.
 - Switch off the circuit breaker or main switch.

Observe the national legal requirements and regulations during electrical installation. In Germany, these include the following safety requirements:

- DIN VDE 0100-100
- DGUV Regulation 1
- DGUV Regulation 3+4
- TRBS 1201

5.4 Location

For professional installation, safe operation and barrier-free access to the charging system, the following points must be observed when selecting the location.

- National or local regulations.
- Do not install the charging system in the hazard areas of:
 - flammable, combustible and explosive materials
 - running or jet water
- Do not install the charging system in the following areas:
 - Areas that are potentially explosive (e.g. petrol stations)
 - Areas where backwater or storm water can be expected
 - Areas where flooding can be expected
 - Areas where heat domes or heat accumulation can occur

- The substrate must have sufficient strength and load-bearing capacity to withstand the mechanical loads.
- Provide sufficient space to maintain the minimum distances:
 - 3 cm from the back of the charging system to other objects; on a concrete base in the case of a mechanical installation
- Ensure heat dissipation and a sufficient fresh air supply for cooling the charging system.
- Observe ambient conditions, see also chapter 3.4 *Technical specifications*, page 18.
- Ensure a stable LTE connection. If necessary, switch to LAN or external LTE antenna. It is recommended to install a duplex network cable (CAT 7).



NOTICE

Unit damage due to unintentional start-up

Vehicles unintentionally running into the unit can cause damage.

- Select the installation site in such a way that damage caused by unintentional collision by vehicles is prevented.
- If damage cannot be ruled out, suitable protective measures must be taken.



INFORMATION

This charging system is not suitable for use in residential areas due to the applicable EMC requirements.



INFORMATION

To protect the charging system, we recommend to install an approach limiter (e.g. bollard).

5.5 Base mounted

Installation sequence

1. Select a suitable location.
2. Check parts and installation material for completeness.
3. Check the substrate.
4. Drill mounting holes.
5. Place connection bracket.
6. Guide the supply cable through the connection plate and fix it in place.
7. Place the metal protective cover on the protective hood.
8. Place and align the charging system.
9. Attach the charging system to the connection bracket with installation material.
10. Prepare electrical installation.

Installation material and tools

- Connection bracket
- 4 pcs. Hexagon head screws M12 x 60 mm, quality min. 8.8, with 4 washers (DIN ISO7039, 13 x 37 mm)
- Torque wrench

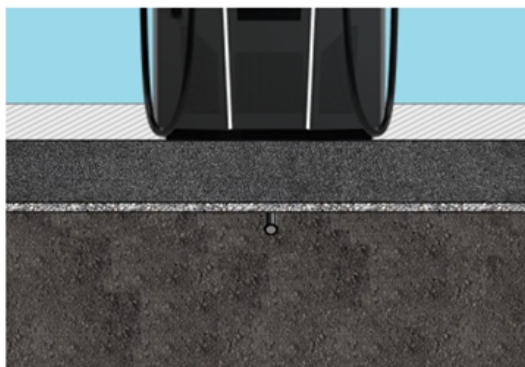

Installation takes place on prepared asphalt or concrete surfaces.

The charging system is then mounted and finally installed.

Refer to the design drawings in the Annex for the dimensions of the charging system.

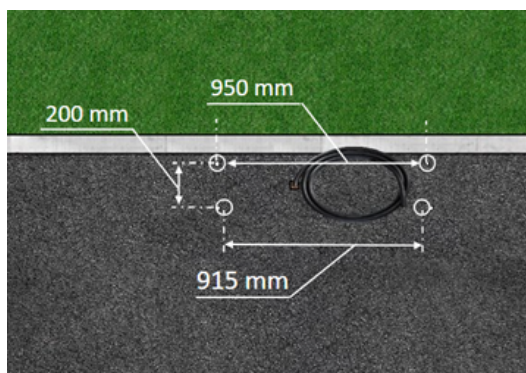

Installation requirements

- Substrate with sufficient layer thickness, consistency and bearing capacity
- Asphalt or concrete thickness of the substrate at least 120 mm
- flat contact surface (tolerance: 1 mm)
- Specifications for boreholes:
 - Clearances: 200 mm and 950 mm above and 915 mm below.
- Opening in the concrete floor through which the connection cables are pulled. Approx. 345 x 97 mm in horizontal direction centred from the mounting holes.

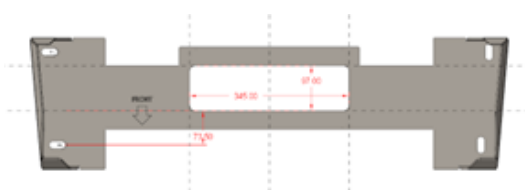



Carrying out installation

1. Mark boreholes. The connection bracket can be used as a template. The marking must point to the front.
2. Drill boreholes according to instructions.
3. Safeguard opening for the connection cables.
4. Screw the connection bracket to the concrete base with M12x60 mm screws (min. 8.8 + washer 13x37) (M = 50 Nm).

5.6 Installation on concrete base

Installation sequence

1. Select a suitable location.
2. Check parts and installation material for completeness.
3. Dig the excavation pit.
4. Check the substrate.
5. Route the power supply cable.
6. Compact and level the ground.
7. Place and align the concrete base.
8. Insert the supply cable into the concrete base and separate.
9. Fill the excavation pit with excavated material and compact the excavated material.
10. Insert base filling material (mandatory).
11. Place connection bracket.
12. Guide the supply cable through the connection plate and fix it in place.
13. Place the metal protective cover on the protective hood.
14. Place and align the charging system.
15. Fasten the charging system with installation material.
16. Prepare electrical installation.

The concrete base is embedded in the ground.

The charging system is then mounted on the concrete base and finally installed. Refer to the design drawings in the Annex for the dimensions of the charging system.

Installation material and tools

- Connection bracket
- 4 pcs. Hexagon head screws M12 x 60 mm, quality min. 8.8, with 4 washers (DIN ISO7039, 13 x 37 mm)
- Torque wrench

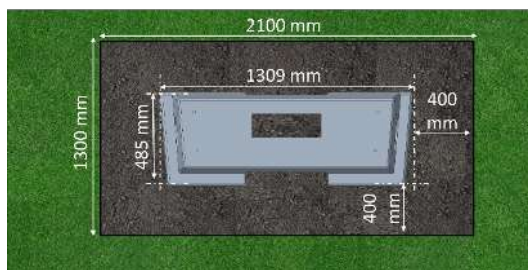

Installation requirements

- Excavation pit
 - Width: 2100 mm
 - Length: 1300 mm
 - Distance to all sides of the concrete base: 400 mm
 - Depth: 600 mm
- flat contact surface of the substrate (tolerance: 1 mm)

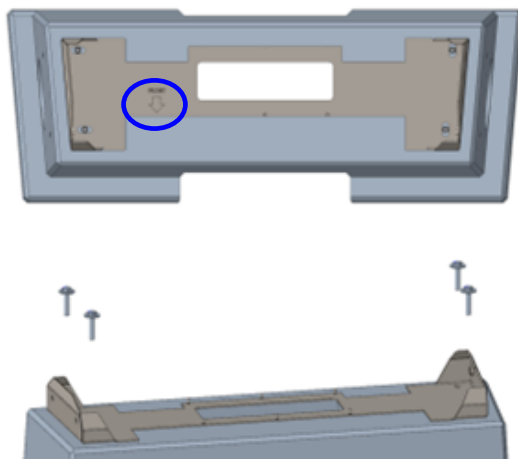
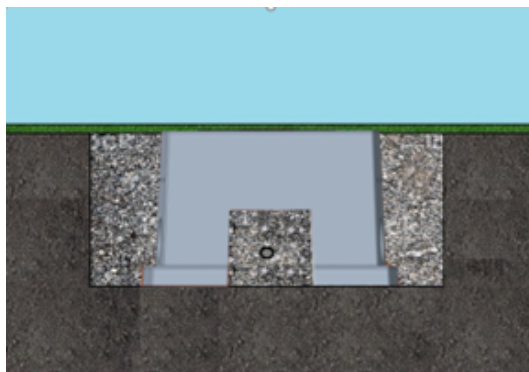
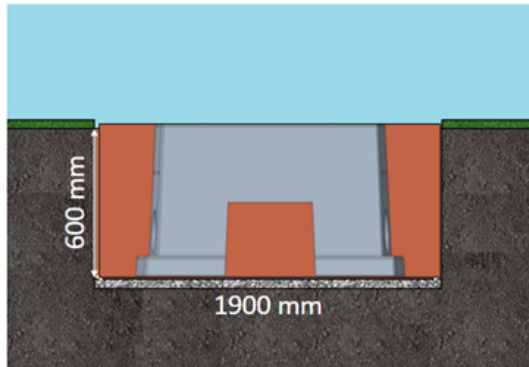

Carrying out installation

1. Dig an excavation pit and prepare it for the stable installation of the charging system.
2. Embed the concrete base into the excavation pit with suitable lifting gear.
 - ⇒ For orientation and alignment, the upper edge of the ground level and the operating side of the charging system are marked on the concrete base
 - ⇒ Concrete base protrudes 20 mm from the ground
3. Insert the power supply cable into or through the concrete base.
4. Fill the excavation pit with excavated material.
 - ⇒ Make sure that the filling of the pit reaches the surrounding ground level.
5. Fill the last 300 mm inside the concrete base with concrete base filling material.
 - ⇒ ½ sack of filling material (Compleo)
 - ⇒ The use of the filling material is mandatory as it reduces the penetration of moisture into the charging system from the ground.
6. Compress the excavation material around the charging system.
7. Align the connection bracket using slotted holes so that it is as parallel as possible to the concrete base. The marking must point to the front.
8. Screw the connection bracket to the concrete base with M12x60 mm screws (min. 8.8 + washer 13x37) (M = 50 Nm).

5.7 Cable gland



DANGER

Danger due to electric current

Damage to the insulation can expose live parts. Touching these parts will cause an electric shock resulting in serious injury or death.

- The outer cable insulation must be kept up to 5 cm above the clamps.

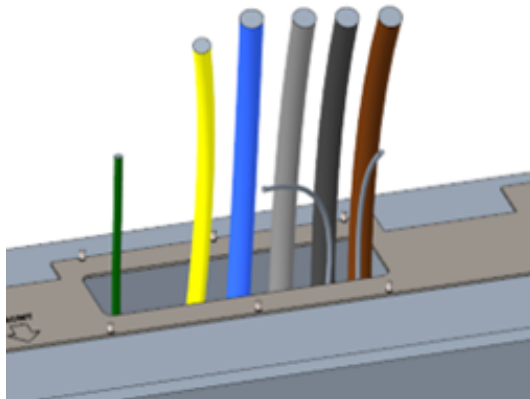

1. Disconnect the supply cable (approx. 500 mm below ground level) and pull individual wires through the connection bracket.

⇒ **Note:** The power electronics require a clockwise rotating field. The phase sequence "L3 - L2 - L1" must be observed.

⇒ The individual wires of the supply line should protrude approx. 400 mm above the ground.

⇒ The data line should protrude at least 700 mm above the ground.

⇒ The connection line of the PA connection is guided through the left cable gland and should protrude approx. 166 mm above the ground.

2. Fill the opening sufficiently with base filler.

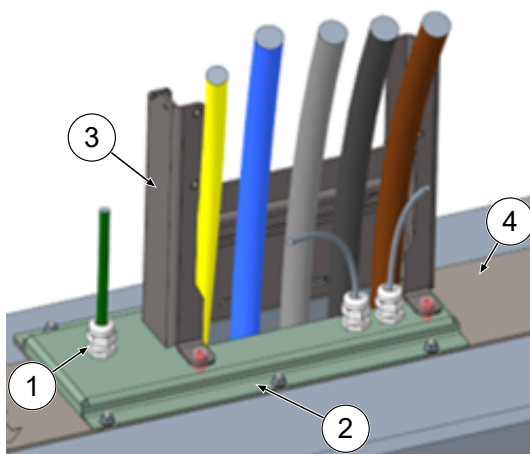

3. Fit the cable glands (1) to the connection plate (2)

4. Place the connection plate on the connection bracket (4).

5. Feed the connection line of the PA connection (green) and network cables (grey) through the cable glands.

6. Screw the connection plate with 6 x M6 nuts onto the connection bracket (SW10) (M=6 Nm).

7. Tighten the cable glands.

8. Insert the protective cover (3) at the rear and tighten 2 x M8 cylinder head screws at the front with 5 mm hexagon socket screws (M = 15 Nm).

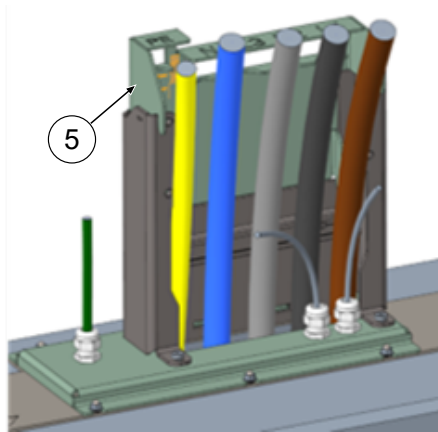

9. Attach the connection template (5) to the protective cover and bend the cables that still need to be shortened forwards.

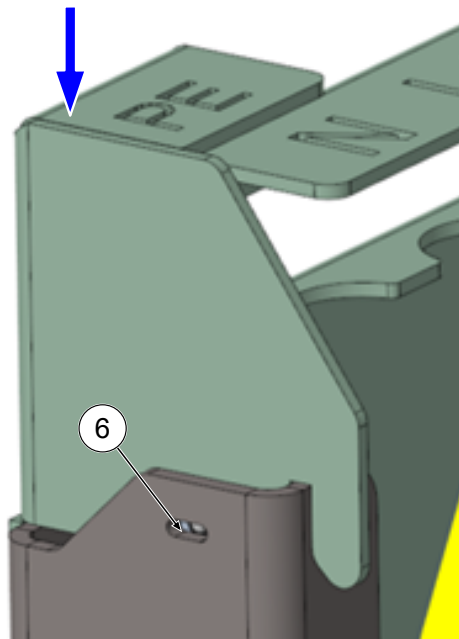

10. Lower the connection template until the lateral ball thrust pieces (6) snap into place on the protective cover.

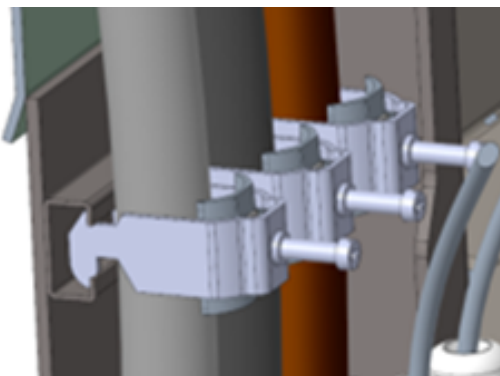

11. Fix the lines to the C-rail with the supplied bracket clamps (cross slot) (M=2 Nm).

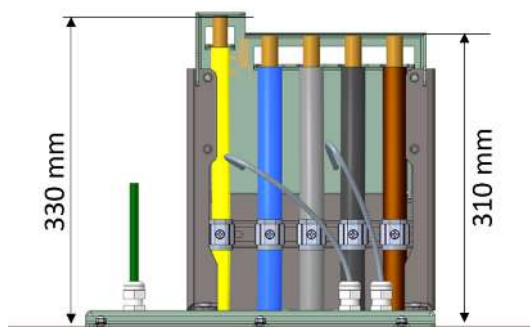

12. Use the template to shorten the lines so that they fit under the template. Lengths via connecting plate:
- ⇒ PE = 330 mm
 - ⇒ Supply lines = 310 mm above connection plate.

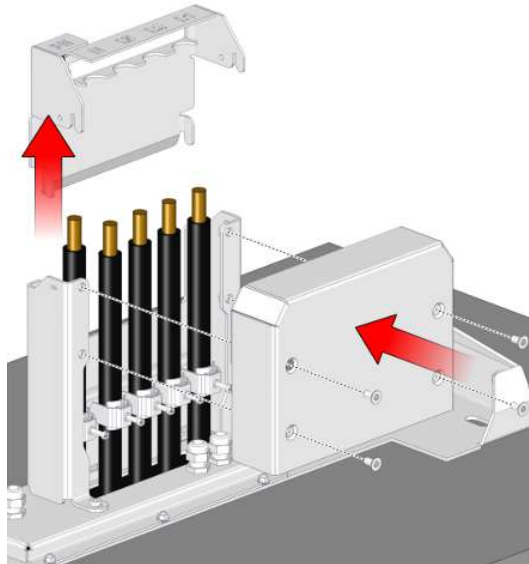
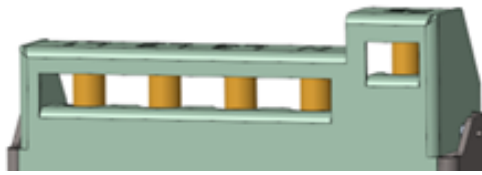

13. Strip approx. 35 mm of the insulation from the cables. The insulation can be marked through the window on the back of the template.
14. Remove the connection template again.
15. Place the metal protective cover on the protective hood and screw tight with the 4 countersunk screws (4 x M8; TX45; M = 15 Nm).



NOTICE

Damage to the electronics

When fitting the charging system on the connecting plate, the power electronics can be damaged if the supply cables become entangled.

- Fit the corresponding protective cover onto the connection template.

5.8 Installation of the charging system

The charging system is lifted over the protective cover and then lowered. This can be achieved with the help of a forklift or lifting gear.



WARNING

Suspended loads

Falling loads can cause serious injury or death.

- Never step under suspended loads.
- Attach slings only to the designated attachment points.
- Only use approved lifting gear and slings in perfect condition with sufficient load capacity.
- Transport the load close to the ground and set it down immediately after transport to its destination.



WARNING

Danger from falling charging system

When the door is open, the centre of gravity of the charging system shifts enough to allow the charging system to fall off the fork of the forklift.

- Make sure that the door of the charging system has been locked before transport.

5.8.1 Lifting via roof attachment points



INFORMATION

The lifting gear must be designed for a transport weight > 1000 kg.



1. Remove the middle plug.



2. Screw in the eyebolts (M12) as far as they will go.

3. Attach suitable lifting gear to the two eyebolts.

5.8.2 Lifting with a forklift

Lift the charging station using a forklift in the openings provided on the base or using a crane on the roof.

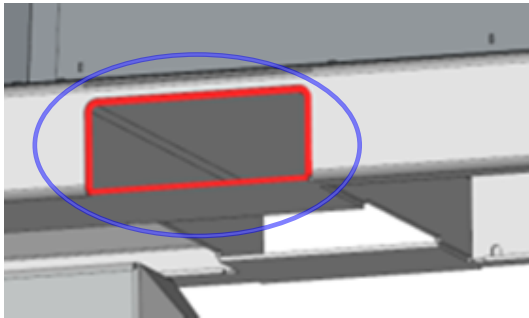

1. Remove the lamellar plugs from the forklift openings on the unit base. The forklift openings must be closed again with the lamellar plugs after transport.
2. Insert the forks of the forklift into the openings provided on the base.

5.8.3 Placing charging system on connection bracket

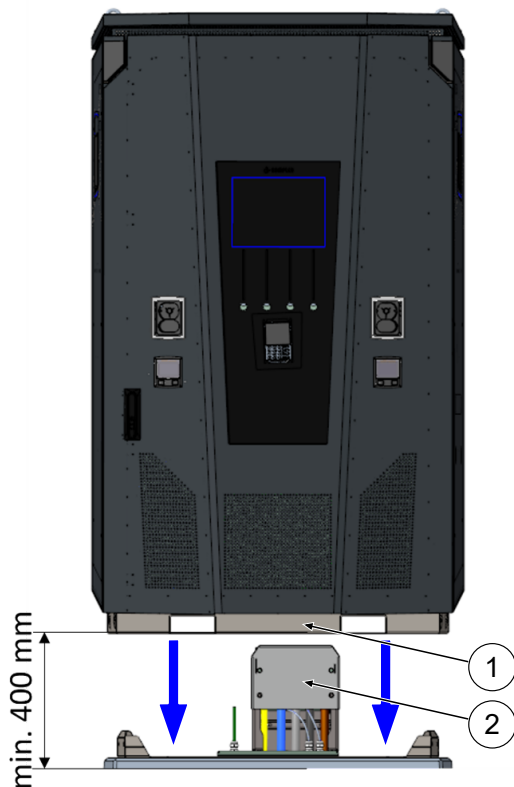

1. Lift charging system at least 400 mm.
2. Place charging system above connection bracket. The insertion funnel (1) in the base of the charging station must be aligned as close as possible to the protective cover (2) of the connection.
3. Slowly lower the charging system and secure it against tipping. When the charging station is set down, it is aligned using the insertion aid. If it gets stuck at any point when setting it down, carefully lift it again and realign.

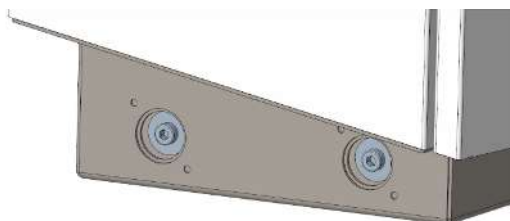

4. Screw the housing of the charging system to the side at 4 points with the connection bracket. (M 12 screws plus body screws).
5. Close openings with the caps provided.

5.9 Folding out the ventilation and removing the protective cover

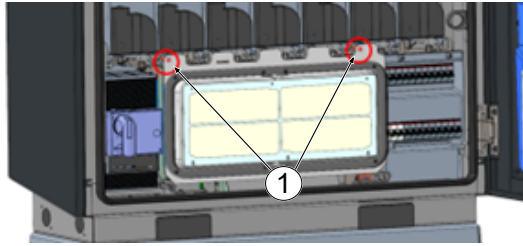

1. Loosen both screws (1) on the ventilation until the fan can be moved.
Attention: Do not remove the screws completely!

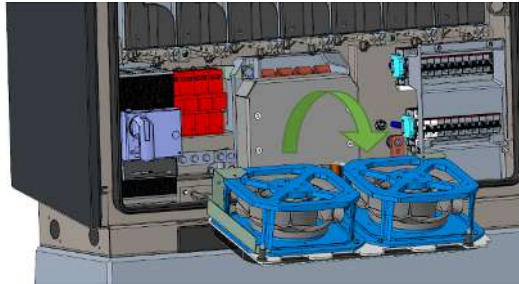

2. Pull the ventilation forward and fold it out.

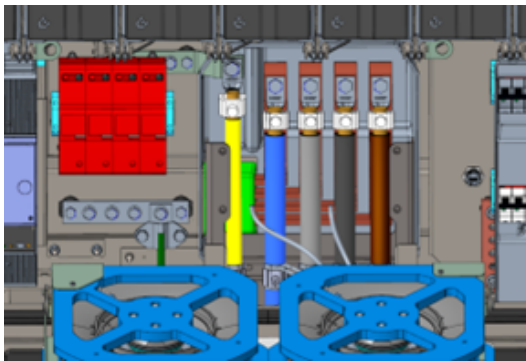

3. Remove protective cover.

5.10 Connecting the supply cable

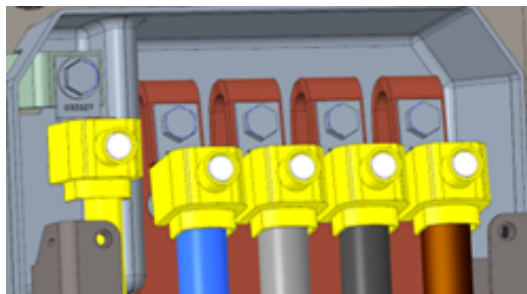
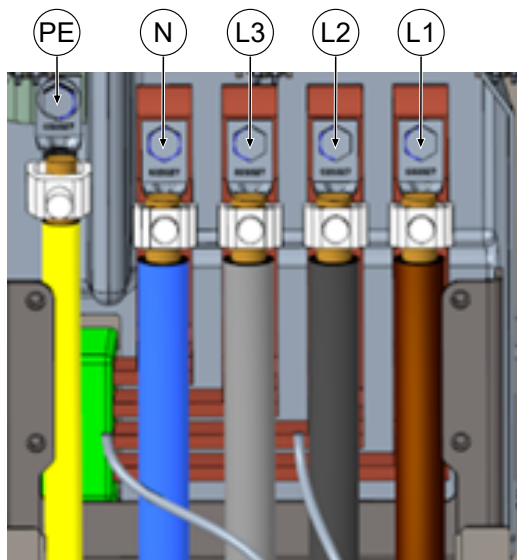

1. Connect the connection cable to the busbars using the enclosed V-terminals or double V-terminals as shown in the adjacent illustration (M10 external hexagon, SW17, M = 35 Nm).
2. The conductor cross-section must be selected taking into account the maximum charging capacity and the length and installation method of the power supply cable.
 - ⇒ L1/L2/L3: max. 240 mm²
 - ⇒ N: min. 25 mm², max. 240 mm²
 - ⇒ PE: min. 0.5 x [L1/L2/L3], max. 240 mm²
3. Place plastic caps on V-terminals.
4. Fit the supplied protective cover (1) (TX45, M = 15 Nm)
5. Fold the ventilation back in and secure it.



NOTICE

Space problems with the connection

When using double cables, the cores must be laid on top of each other and connected to the terminals.



INFORMATION

Do not fix laid data cables to the copper rails.

5.11 Equipotential bonding

The necessary equipotential bonding is carried out via the permanently mounted equipotential bonding rail in the housing.

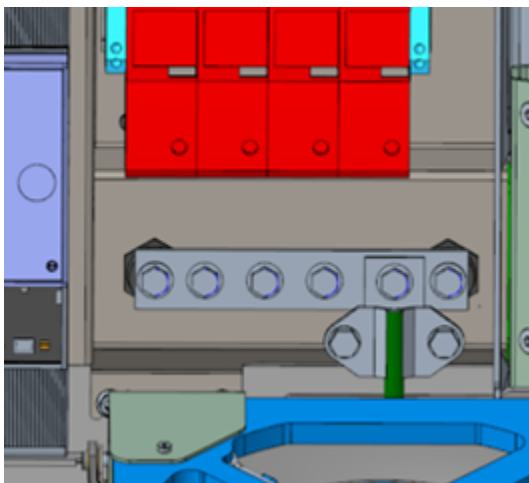

1. Select the conductor cross-section of the cable taking into account the maximum length and installation type.
 - ⇒ Round wire V4A: max 10 mm², or
 - ⇒ Flexible conductor: max. 35 mm² with M8 compression cable lug, angled at 45°.
2. Cut the conductor to length as required and screw onto the rail.
 - ⇒ M8 x 20 connection screw; M = 20 Nm.

3. Ensure that the conductor is connected correctly and that the fastening screw is tightened to the specified tightening torque.
4. Replace all covers that may have been removed previously.



NOTICE

Equipotential bonding connection for surge arresters

- When connecting a type 1+2 surge arrester, the equipotential bonding connection must be connected to a possibly installed equipotential bonding rail or to a local earth electrode.

5.12 Data connection via RJ45 plug

The charging system is connected to an existing network via an internally installed switch using an RJ45 plug.

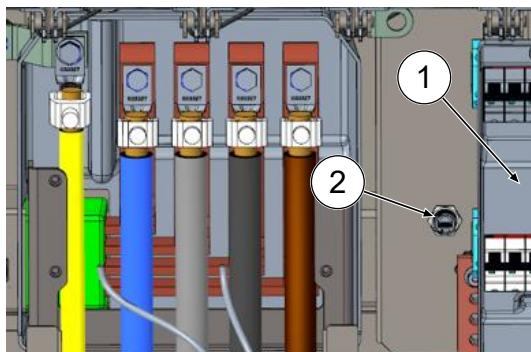

1. Remove the contact protection of the MCB (1).
2. Insert the network cable with RJ45 plug into the slot (2).
3. Refit the contact protection of the MCB.



NOTICE

The minimum cross-section of the individual strands of the network cable must be below AWG 26. When using a smaller cross-section, it cannot be guaranteed that a connection can be established.

5.13 Cable management system

Installation material and tools

- Ratchet box
- Socket external Torx T25
- Hexagon socket 8 mm
- Open-end wrench SW 19
- Torque wrench

5.13.1 Preparing for installation

1. Loosen the front screws of the roof fastening (see also chapter 11.3 *Replacing the filter mat at the air outlet, page 90*).
2. Fold up the roof and secure it.
3. Loosen and remove the slotted nuts and washers of the Puck antennas.
4. Pull the antennas out to the end of the cable loop. Loosen any attached cable ties beforehand.
5. Close the roof and secure it again with the fastening screws. Make sure that the antenna cable is not pinched.
6. Remove the plugs from the fastening threads on the left and right of the roof.
7. Remove the cable management system from the packaging and place it on the floor.

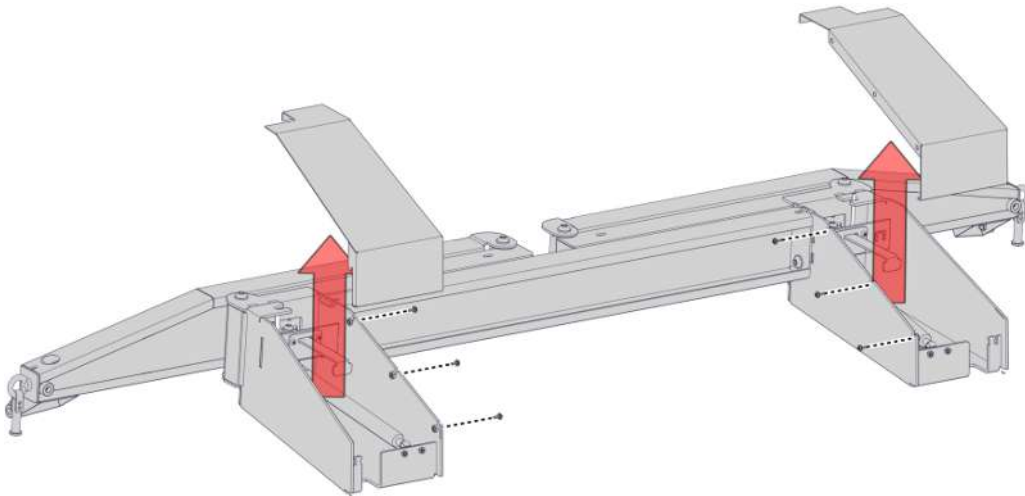

8. Loosen the screw connection of the console hoods, remove the hoods upwards.

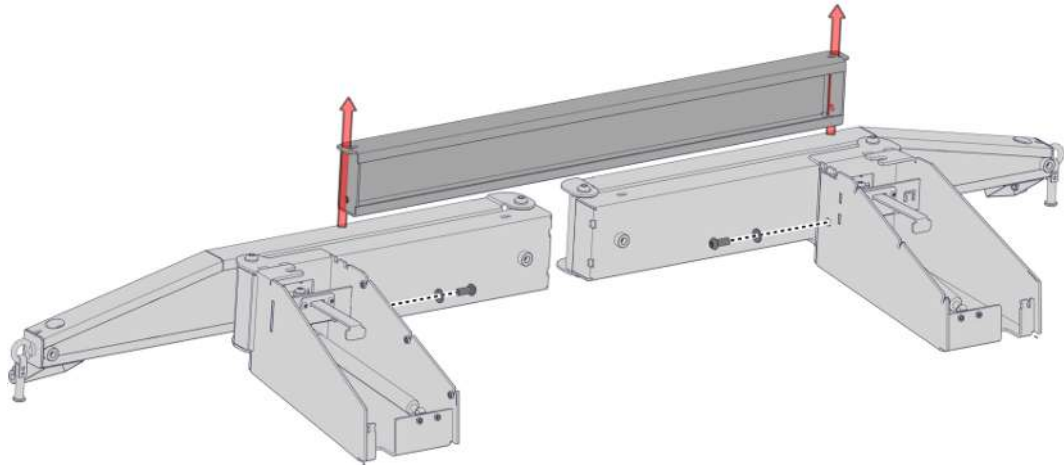

9. Loosen the screw connection of the cross strut and remove the cross strut.

5.13.2 Mounting the KMS

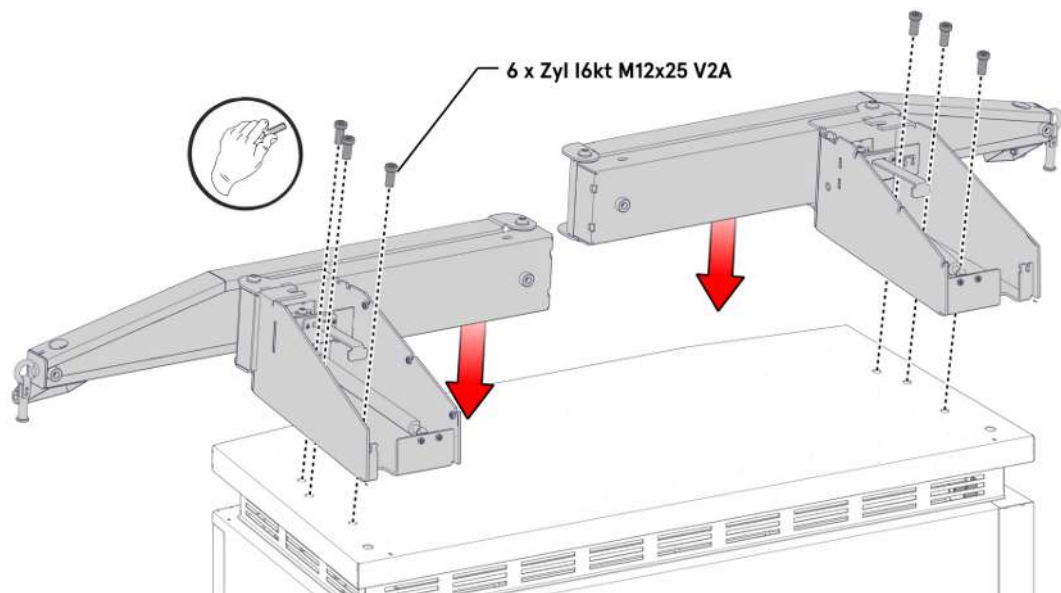

1. Place the left console on the left side of the roof and align it until the fastening threads match the screw holes.
2. Mount the bracket hand-tight with 3 M12 screws through the mounting holes.
3. Fit the right-hand bracket in the same way on the right-hand side.

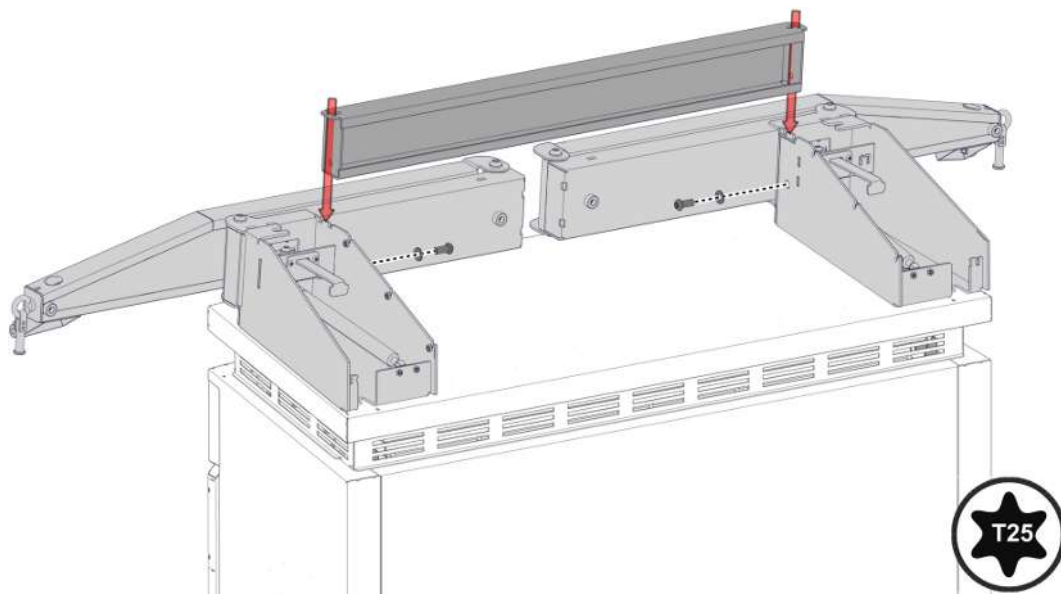

4. Fit the cross strut between the brackets, align according to the hole pattern and tighten with the corresponding screws. For extended pass play, unscrew the bracket screws one turn.

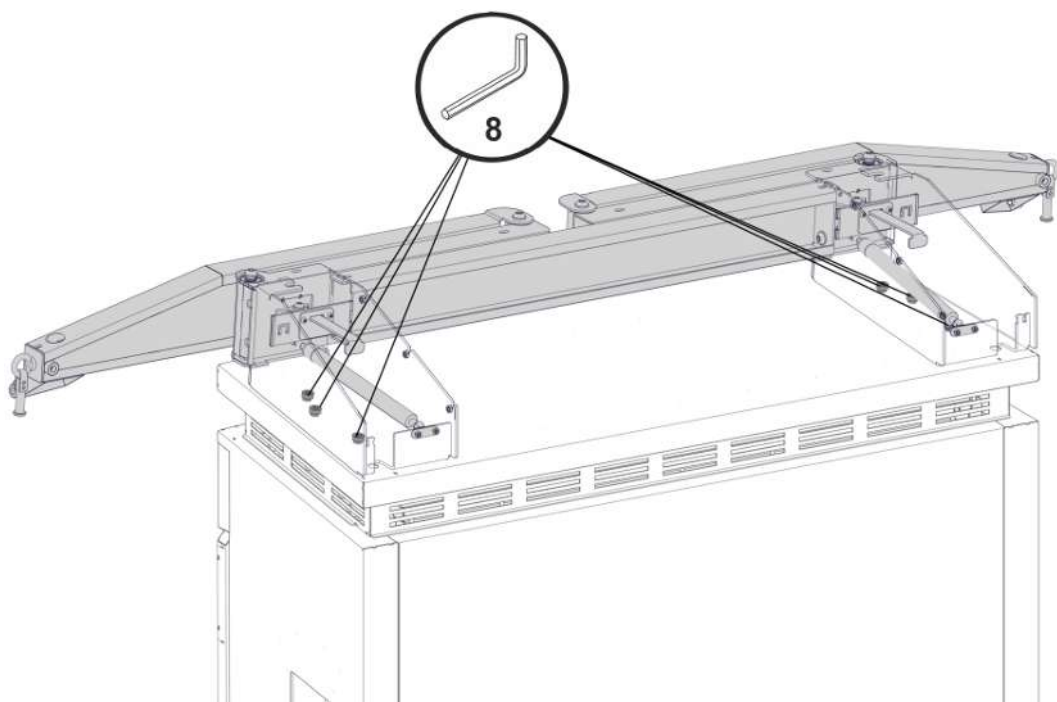

5. Tighten the brackets to the specified tightening torque ($M = 86 \text{ Nm}$).

5.13.3 Position the antennas

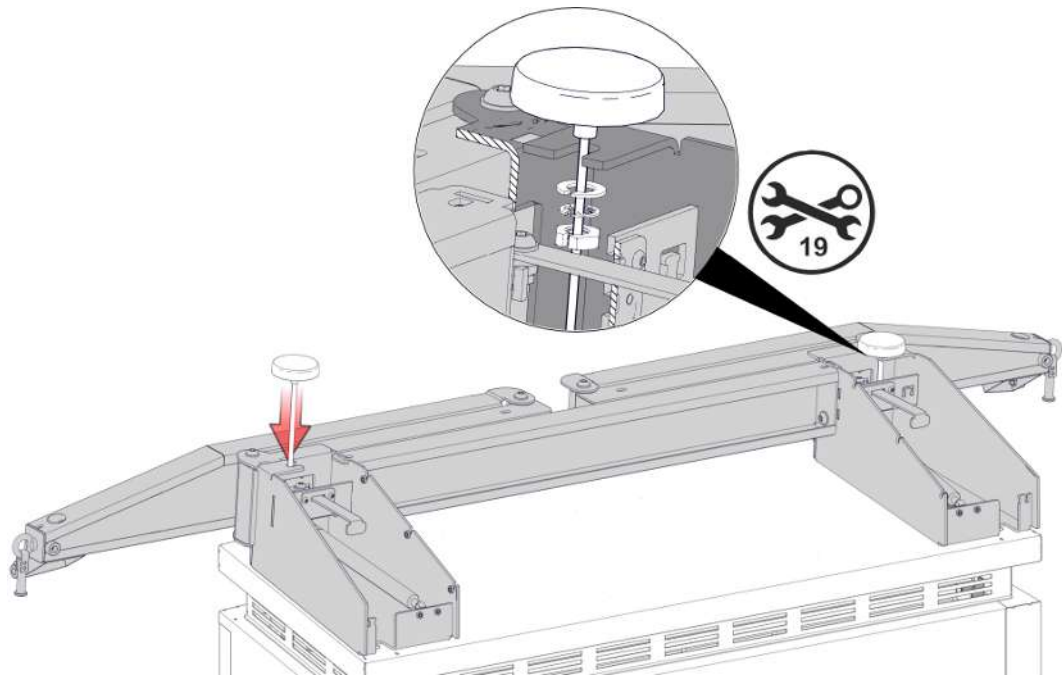

1. Mount the Puck antennas at the designated points on the KMS and fix them with slotted washers and nuts.

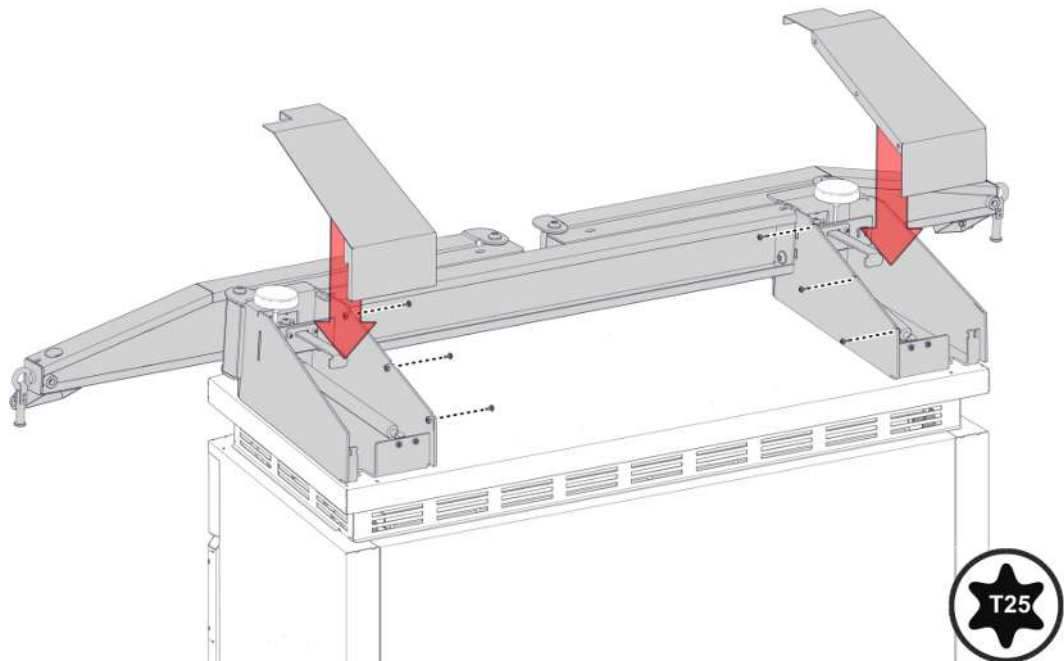

2. Close the covers of the brackets again and tighten them with the corresponding screws.

5.13.4 Mounting the charging cable shell

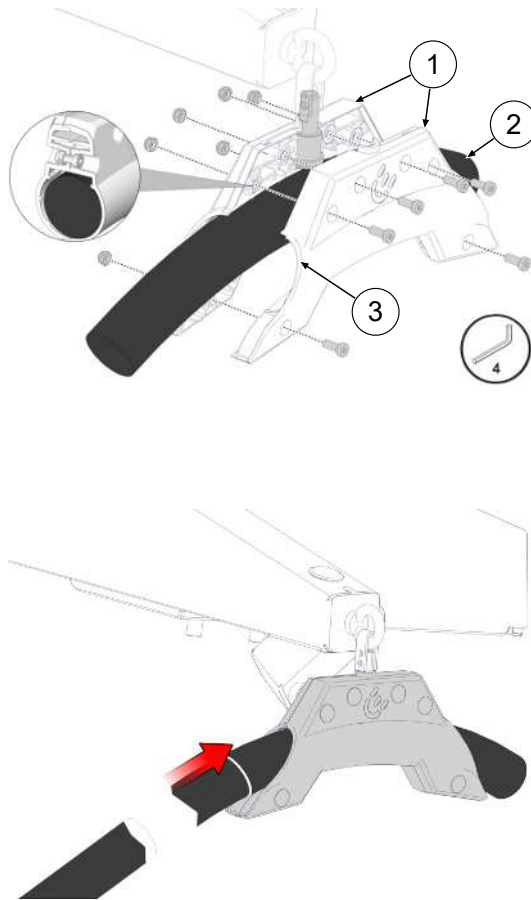

1. Attach the marking to the charging cable at a distance of 3125 mm from the charging plug using an adhesive strip.
2. Position the cable shells (1) around the charging cable (3) so that the side (3) facing the charging plug is in contact with the marking on the charging cable.
3. Fit the cable shells with charging cable around the bearing bolt and secure with the corresponding screws.
4. If necessary, realign the charging cradle at the marking.
5. Tighten the screws to the corresponding tightening torque.

6 Start-up



DANGER

Danger due to electric current

Damage to the charging systems or components may expose live parts. Touching live parts will result in electric shock with serious injury or death.

- Only operate the charging system when it is undamaged.
- In the event of damage, immediately disconnect the charging system from the power supply at the circuit breaker and take suitable safety measures to prevent it from being switched on again.
- Work on electrical components may only be carried out by a qualified electrician.
- Repair work may only be carried out by the customer service.

- Commissioning must be carried out by a qualified electrician or by a person trained and instructed in electrical matters.
- The effectiveness of the protective measures and the correct mechanical and electrical installation must be checked by a qualified electrician prior to commissioning.
- Commissioning may only be carried out when all necessary internal covers are fitted and the housing is completely closed.
- During commissioning, the national legal requirements and technical regulations must be observed.



INFORMATION

The appendix to this manual contains a test report, the test steps of which are derived from the German standards DIN VDE 0100-600 and DIN VDE 0105-100.

Deviating or supplementary national regulations must be observed!

See chapter 13.3 *Commissioning and test reports*, page 100.

6.1 System start-up

After the charging system has been correctly installed, the system can be started.

1. Switch on the power supply.
2. Switch on the line and residual current circuit breaker.

⇒ The system starts up.

The duration of the system start-up may vary depending on the type of charging system, configuration and product characteristics. The successful completion of the system start-up is indicated by the status LEDs and the display according to the configuration and product scope of the charging system. The average start-up time is approx. 60 seconds.

A successful system start-up is indicated by the LED of the respective charging point temporarily lighting up green. In the case of a charging system with display, the message "Ready for operation" also appears for the respective charging point.

In addition to the displays mentioned above, the current counter reading and the message "Ready for operation" are shown on the display of any memory and display module (SAM) installed.



INFORMATION

If explicitly requested by the customer, the back-end connections can be configured and tested at the factory. In this case, the back-end connects directly to the associated charging system after applying the operating voltage. This process may take a few minutes.



INFORMATION

The payment terminal can only be started up with the support of Service.

7 DUCTO web interface

7.1 Configuration of the charging system with DUCTO

DUCTO refers to the software used to manage Compleo charging systems using an end device.

Various parameters of the charging system can be set via the configuration interface.

The charging system management information is stored on the charging system itself. By specifying the IP of the charging system in the browser of a suitable end device, such as a notebook, a start page is called up and the connection to the charging system is established. After logging in, an overview of the parameters that can be called up or changed is listed.

To connect to the charging system, the end device used must have an IP address in the same IP address range.



INFORMATION

The following steps are illustrated using the example of a network configuration with Microsoft Windows 10 and a simulated charging system.

The user must have administrator rights for network configuration.

7.2 Creating a network connection

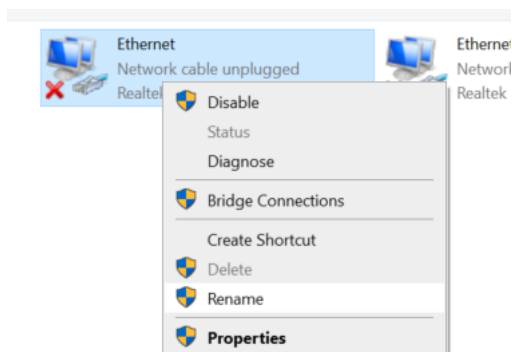

1. Connect a network-compatible end device or computer to the data line of the charging system.
2. Follow the command path: Control Panel -> Network and Internet -> Network Settings.
3. Show and open the properties of the corresponding Ethernet connection by right-clicking.

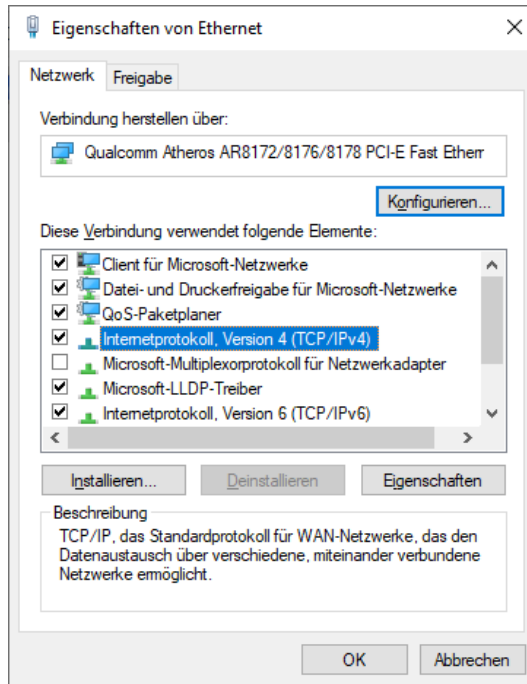

4. Open Properties of <...(TCP/IPv4)>.

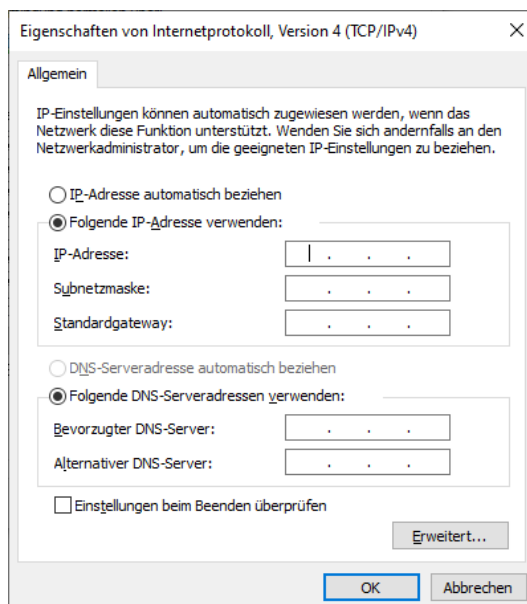

5. Enter the IP address from the range 192.168.1.xxx.

⇒ The charging system is displayed as a network connection.

Note: The IP 192.168.1.100 is assigned for the charging system and must not be used for the configuration of the end device or the computer.

7.3 Calling up the configuration interface



1. Identify password on DUCTO sticker.
2. Open the local browser and enter the following IP address: `https://192.168.1.100`.

⇒ The DUCTO start page is displayed.

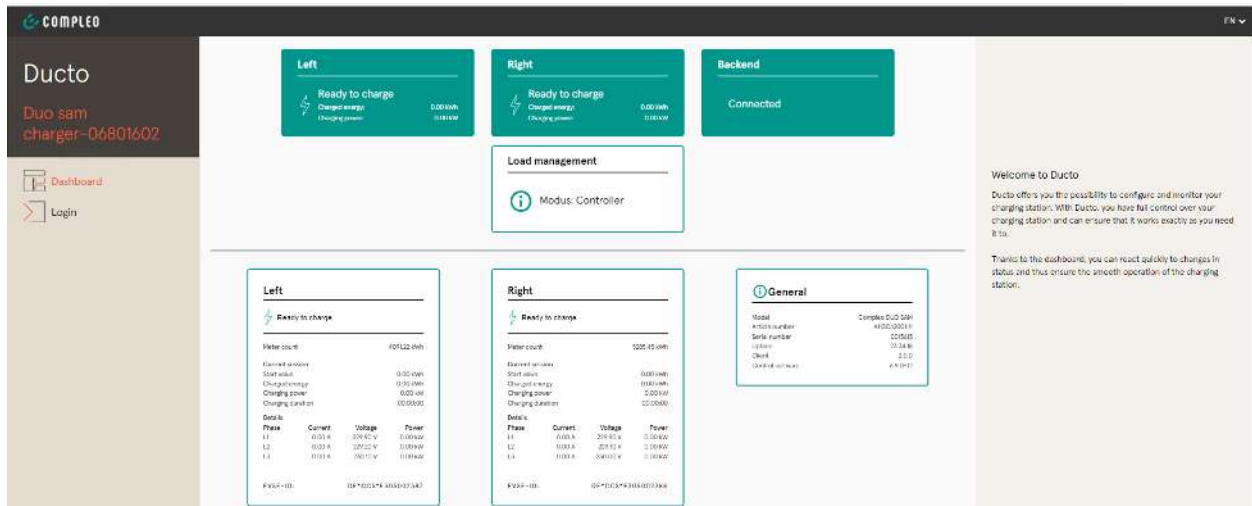

The start page shows information about the status of the charging interfaces.

7.4 Login

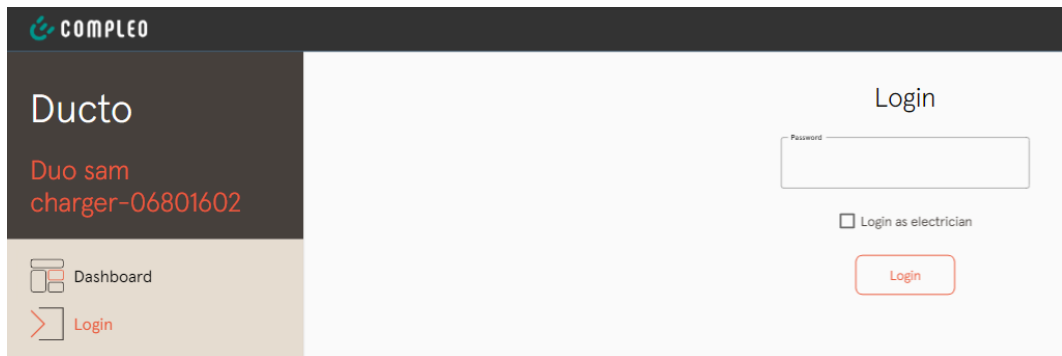

1. Click <Login> in the the left menu ribbon.
 ⇒ The Login window is displayed.

7.4.1 Selecting the language

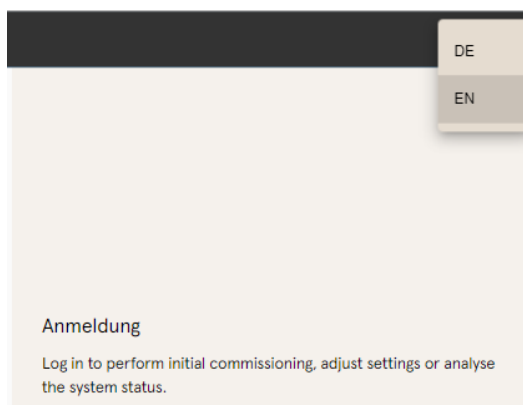

1. Click on the language selection arrow on the right-hand side of the header.
 ⇒ The language selection dialogue opens.
2. Click to select the desired language.



INFORMATION

Changing the language discards changes to the settings that have been made in the current window but not yet applied.

7.4.2 Operator login

After logging in as an operator, the user can set various parameters.

Settings that require the knowledge of a qualified electrician are not available.

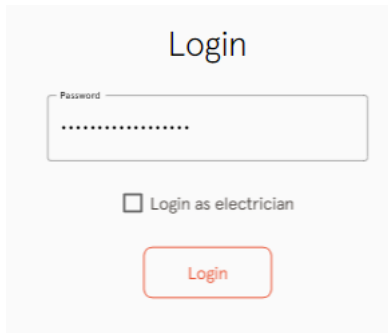

The screenshot shows a login form titled "Login". It features a password input field with a "Password" label and a masked password ".....". Below the input field is a checkbox labeled "Login as electrician". At the bottom of the form is a red "Login" button.

1. Enter password.
 2. Click <Login>.
- ⇒ The user is registered as the operator.
- ⇒ The configuration interface is displayed.

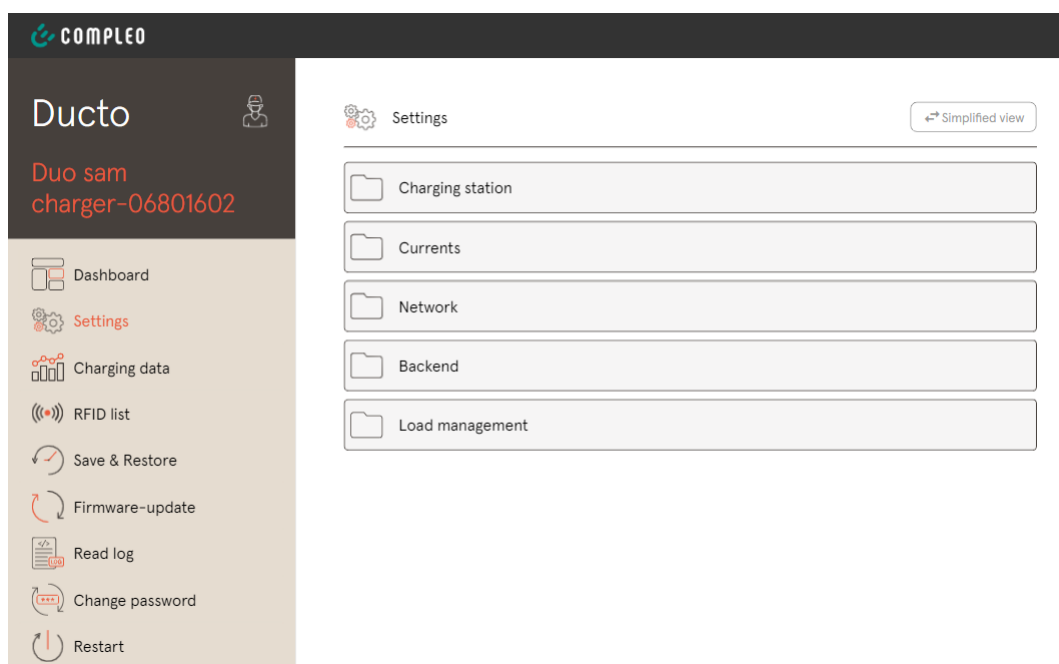

The screenshot displays the operator's dashboard. The top header shows the "COMPLEO" logo. The main header area includes the text "Ducto" and the user information "Duo sam charger-06801602". A left sidebar menu lists various functions: Dashboard, Settings (highlighted), Charging data, RFID list, Save & Restore, Firmware-update, Read log, Change password, and Restart. The main content area is titled "Settings" and includes a "Simplified view" toggle. Below the title, there are five folder-like icons representing different settings categories: Charging station, Currents, Network, Backend, and Load management.

7.4.3 Logging in as qualified electrician

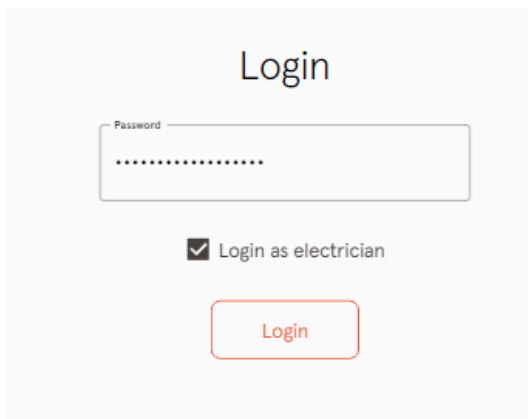

1. Enter password.
2. Tick the check box <Log in as qualified electrician>
3. Click <Login>.

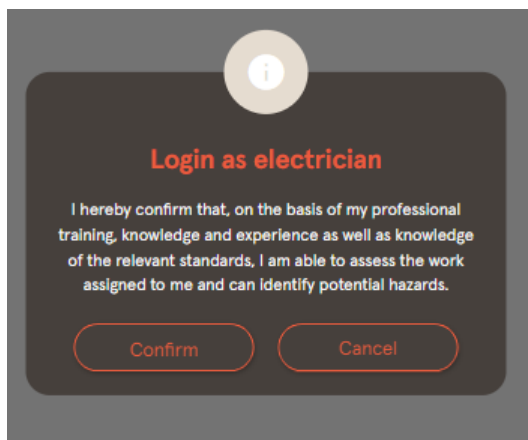

4. Click <Confirm> to confirm qualification.
- ⇒ The user is registered as an electrician.
 - ⇒ The configuration interface is displayed.

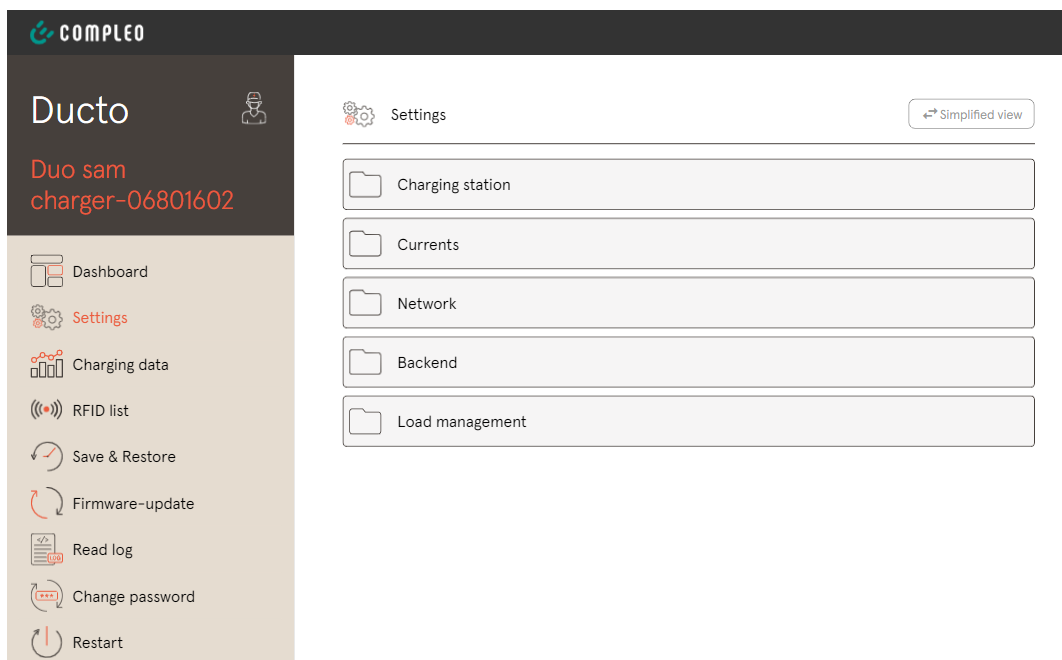

7.5 Design of DUCTO

DUCTO has a three-column design in the desktop view.

In the left-hand column, the menu ribbon lists all high-level functions.

The content of the centre column is usually used to select settings or list entries.

The content of the right-hand column is used for general orientation or for editing settings and entries. The differences depend on the selected function.

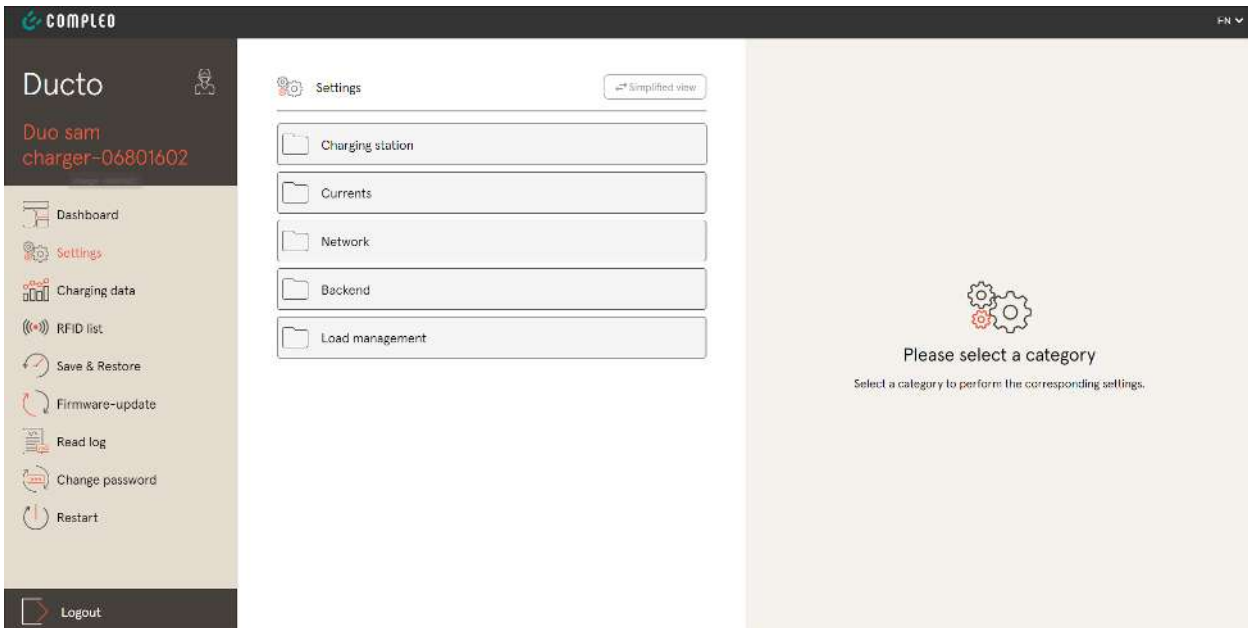

7.6 Dashboard

The dashboard is the default start setting for DUCTO.

It shows a complete overview of the charging state of a charging system addressed.

The figure below shows the charging state of the Compleo example system.

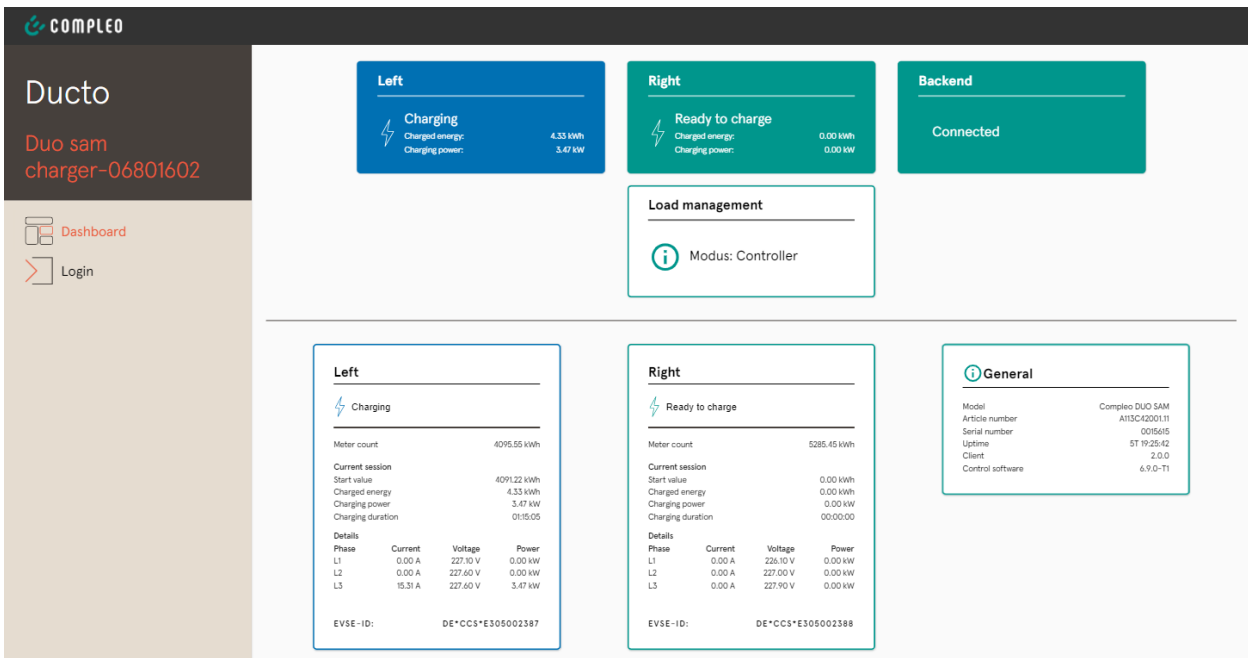

7.7 Settings

After logging in, the associated categories are listed in the simplified view in the "Settings" function.

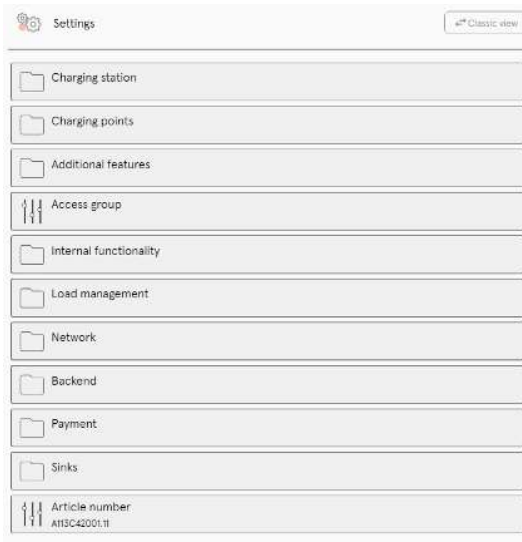
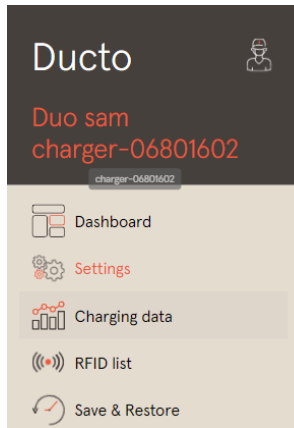

1. Click on the <Simplified view> button.
⇒ The view changes to "Classic view".
2. Click on the <Classic view> button.
⇒ The view switches back to "Simplified view".

7.7.1 Parameter selection

The settings are organised into various folders of related parameters. Depending on the user's authorisation level, these are only displayed or can be changed.

A distinction is made between the following types of parameters:

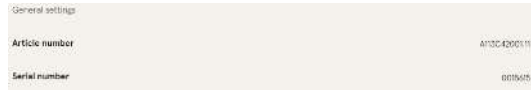

- Read only (see "Article number"; "Serial number")

These values are for information only and cannot be changed.



- Drop-down (see Display language)
- Check box (see Deactivating the beeper)

These values can be changed to predefined values or activated by clicking on them.



- Text field (see EVSE ID of the left or right charging point)

These values can be changed by freely entering text.



- Expert parameters
- Certain expert parameters are only visible when they are displayed.

They are labelled with an "Expert" marking.



Most of the parameters have descriptions that appear by clicking on the parameter title.

These descriptions are labelled with a question mark, which appears when you move the mouse over the parameter title.

7.7.2 Changing parameters

If a writeable parameter is changed, a "Changed" marking appears to provide an overview.

Changes can be confirmed immediately or collectively after all changes have been finalised.

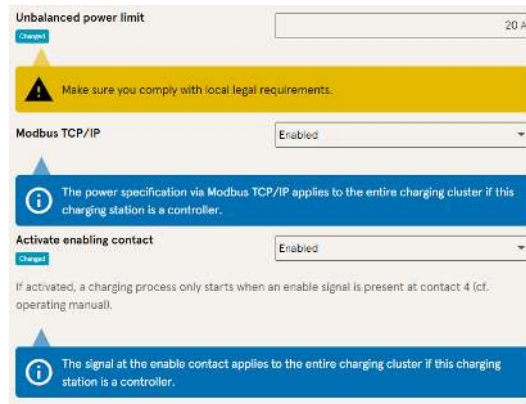

- If a selected setting is incorrect or not standardised, a yellow warning box appears.
- If the setting is unlikely to have the expected effect, a blue info box appears.

7.7.3 Charging station

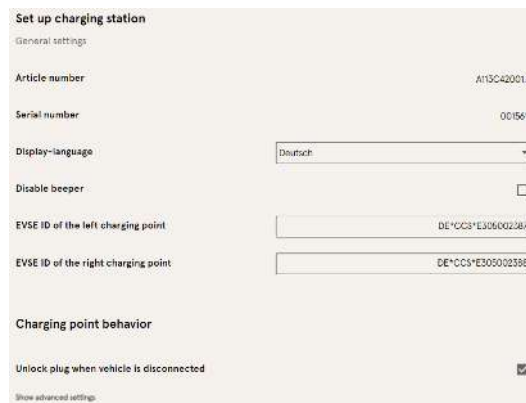

Higher-level parameters that affect the entire charging station can be found here.

7.7.4 Currents

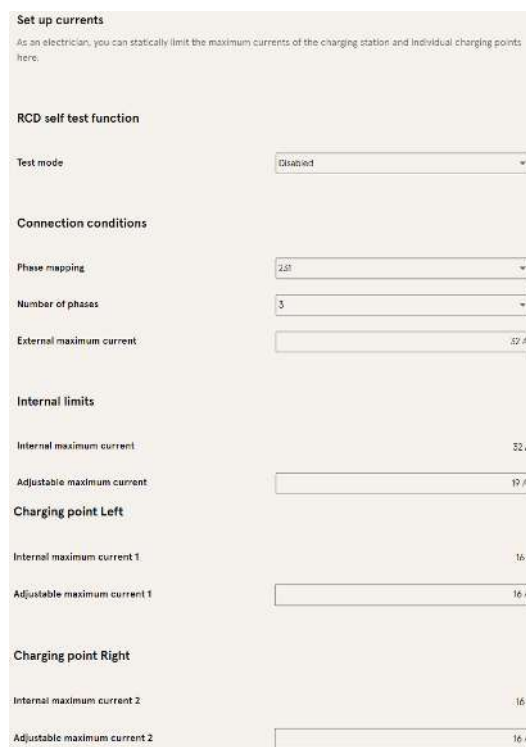

In the "Currents" folder, the electrician can set the RCD self-test function and specify the connection conditions.

The large number of current values is necessary to show the limits specified by the charging station or to define the limits of the connection, which as a rule only the manufacturer or the qualified electrician knows or is authorised to set.

In addition, non-electricians or operators have the option of throttling the charging station as a whole or individual charging points.

This throttling option is labelled "Adjustable".

7.7.5 Network

Set up network
Integrate your charging station into a network here to prepare features like backend, remote access or load management.

Hostname

Obtain an IP address automatically

IPv4 address

Subnet mask

DNS server address

IPv4 gateway address

Activate modem

1. Assign the desired host name.
2. Assign the desired IP address.
3. Enter the subnet mask.
4. Enter the gateway address.



NOTICE

To operate several charging stations in the same network, the first 8 digits of the IP octet must be the same.

In this chapter, the charging station can be integrated into an existing network using the parameters.

7.7.5.1 Backend communication via SIM card of this charging station

The modem must be activated for backend communication via the SIM card.

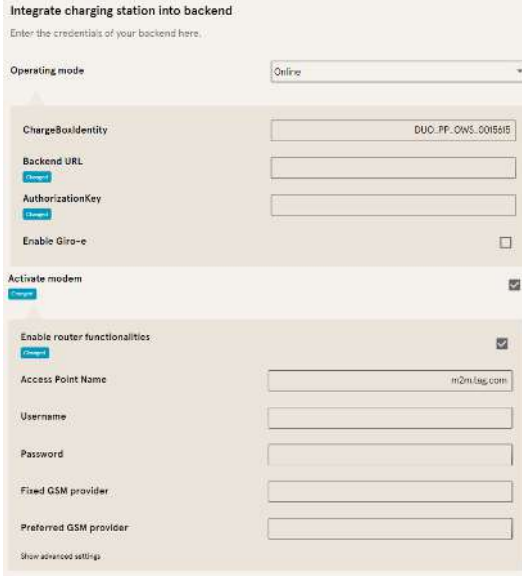

The screenshot shows a web form titled "Integrate charging station into backend" with the instruction "Enter the credentials of your backend here." The form is divided into several sections:

- Operating mode:** A dropdown menu set to "Online".
- ChargeBoxIdentity:** A text input field containing "DUO_PP_QWS_0015615".
- Backend URL:** An empty text input field.
- AuthorizationKey:** An empty text input field.
- Enable Giro-e:** A checkbox that is currently unchecked.
- Activate modem:** A checkbox that is checked.
- Enable router functionalities:** A checkbox that is checked.
- Access Point Name:** A text input field containing "m2m.fag.com".
- Username:** An empty text input field.
- Password:** An empty text input field.
- Fixed GSM provider:** An empty text input field.
- Preferred GSM provider:** An empty text input field.
- Show advanced settings:** A small link at the bottom left.

1. Select the "Activate modem" check box by clicking on it.
2. Enter access point name.
3. Specify user name and password.
4. Enter the fixed or preferred GSM provider.
5. Optional: Click on the "Activate router function" check box if other charging stations are to use the SIM card of this charging station.

7.7.5.2 Backend communication via SIM card in another charging station

If backend communication is to be established via the SIM card in another charging station, this other charging station must be considered as the gateway.

See Chapter 7.7.5.4.1 *Specifying your own IP address*, page 58

7.7.5.3 Preparing onboard charge management

1. Follow the instructions in Chapter 7.7.5.4.1 *Specifying your own IP address*, page 58.
2. Repeat these steps for each charging station.



INFORMATION

All charging stations equipped with a SIM card are capable of being both charge management controllers and routers for the backend communication of other charging stations.

The charge management controller does not necessarily have to be a router if both functions are to be used.

7.7.5.4 Preparing backend communication via LAN



INFORMATION

A router with an Internet connection or a charging station with a SIM card is required for backend communication via LAN.

7.7.5.4.1 Specifying your own IP address



Obtain an IP address automatically

IPv4 address	<input type="text" value="10.102.221.93"/>
Subnet mask	<input type="text" value="255.255.255.0"/>
DNS server address	<input type="text"/>
IPv4 gateway address	<input type="text" value="10.102.221.1"/>

1. Enter an IP address that is unique in the LAN.
2. Enter the subnet mask (usually 255.255.255.0).
3. Optionally, enter the DNS server and gateway address. The gateway address is the address of the router or charging station with SIM card.

7.7.5.4.2 Obtain IP address automatically

The IP address can be obtained automatically.

After this, it is no longer possible to use the routing of the backend communication via the SIM card of another charging station or to set up charge management.



NOTICE

Charging station not accessible

If an IP address is assigned automatically, a DHCP server (router) must be available in the network.

Without this server, the charging station is no longer accessible via the network.

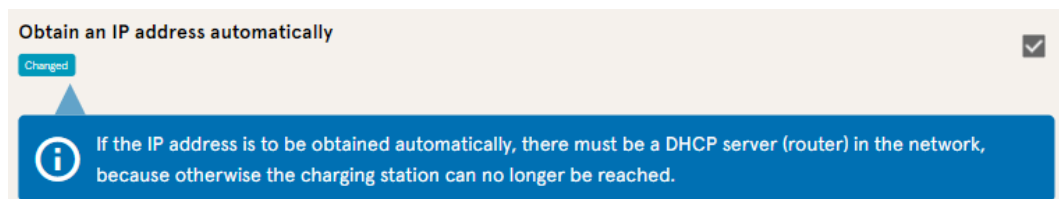

Obtain an IP address automatically

Changed

! If the IP address is to be obtained automatically, there must be a DHCP server (router) in the network, because otherwise the charging station can no longer be reached.

1. Select the "Obtain IP address automatically" check box by clicking on it.
2. IP address is assigned automatically.

7.7.5.5 Accessing Ducto remotely

Ducto can also be accessed from outside the local network under certain conditions.

7.7.5.5.1 Accessing Ducto via VPN

The charging station can be accessed via VPN if it is integrated into a local network with Internet access.

An exception is the backend connection of a charging station via the APN SIM card of another charging station. The port enable from a charging station with an APN SIM card is automated there.

7.7.5.5.2 Accessing Ducto via APN-SIM card

If the SIM card used is an APN SIM card with a detectable IP address, Ducto can be accessed from the corresponding APN via the IP address of this SIM card.

If this is available, it is also displayed on the dashboard.

If several charging stations are operated via an APN SIM card, the other charging stations can be reached via the address `https://<IP address of the SIM card>:44***`.

The asterisks must be replaced by the last octet of the fixed IP address of the charging station without SIM card.

Example:

- ✓ The SIM card of the charging station with router functions has the IP address 10.102.221.93
 - ✓ The static IP address of the neighbouring charging station, which communicates via it, has the IP address 192.168.1.101.
 1. Enter `https://10.102.221.93:44101` in any browser.
- ⇒ The last charging station is accessible.

7.7.6 Backend

This chapter concerns entering the parameters for a backend connection.

The prerequisite for this is an existing network connection (see Chapter 7.7.5 *Network*, page 56).

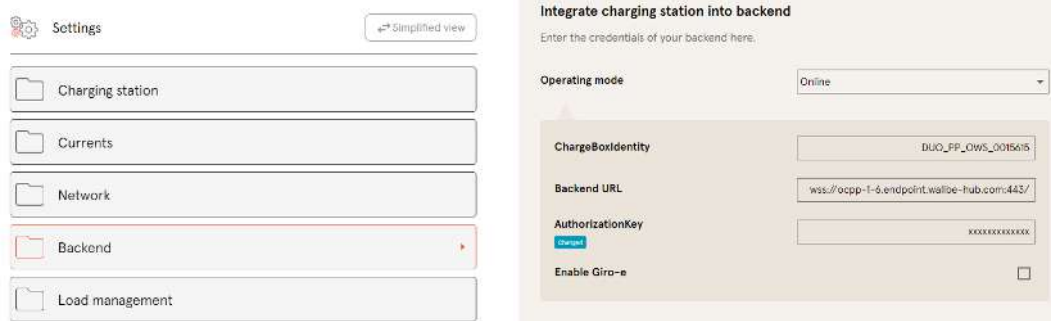

INFORMATION

The AuthorisationKey is required when using a wss URL. This is generally used when connecting to the backend via LAN.

When connecting via SIM card, however, a ws URL is usually used, which is secured via the access data for the APN.

7.7.7 Payment



INFORMATION

This folder is only visible if a payment terminal is integrated.

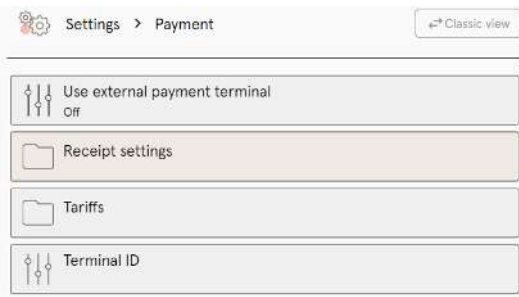

1. Click the "Simplified view" button.
 - ⇒ The "Classic view" appears.
2. Open the "Payment" folder.
3. Enter the terminal ID, company address and location of the charging station in the appropriate fields.

7.7.8 Offline operation

This folder determines whether charging is to take place with or without authorisation.



INFORMATION

This folder is only visible if the operating mode under backend is set to "Offline".

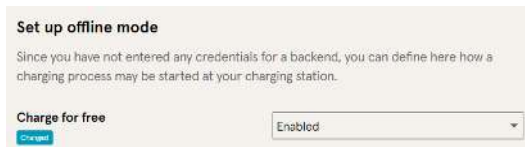

Set up offline mode
 Since you have not entered any credentials for a backend, you can define here how a charging process may be started at your charging station.

Charge for free Charge! Enabled

Charging without authorisation (charge for free)

1. Select "Activated" in the drop-down field.
- ⇒ Charging without authorisation is activated.

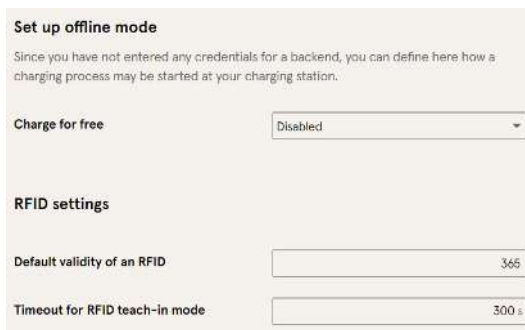

Set up offline mode
 Since you have not entered any credentials for a backend, you can define here how a charging process may be started at your charging station.

Charge for free Disabled

RFID settings

Default validity of an RFID 365

Timeout for RFID teach-in mode 300 s

Charging with RFID card

1. Select "Deactivated" in the drop-down field.
 - ⇒ Charging can only take place after RFID authorisation.
 - ⇒ Set up RFID list (see Chapter 7.9 RFID list, page 65).
2. Set the validity of the RFIDs.
3. Set the timeout for RFID teach-in mode.

Optional authorisation

Alternatively, "Charge for free" with "RFID optional" can be activated.

In this case, the order in which the RFID card is presented and the vehicle is plugged in determines the type of activation.

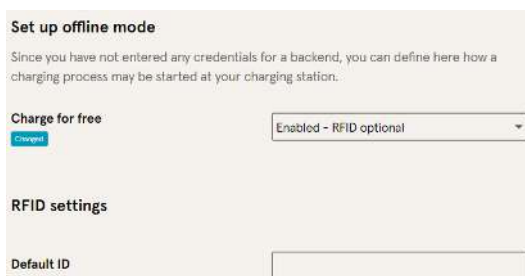

Set up offline mode
 Since you have not entered any credentials for a backend, you can define here how a charging process may be started at your charging station.

Charge for free Charge! Enabled - RFID optional

RFID settings

Default ID

1. Select "Activated - RFID optional" in the drop-down field.
2. Specify default ID.

Scenario 1: Charging process with RFID card

1. Present an RFID card.
2. Plug in the vehicle and charge.
3. End the charging process by presenting the RFID card again.

Scenario 2: Charging process without RFID card

1. Plug in the vehicle.

- ⇒ The charging process is authorised via the optionally assigned standard ID, otherwise a time stamp is used.

7.7.9 Charge management



NOTICE

All charging stations must be in the same IP address range (octet) (see Chapter 7.7.5 Network, page 56)



INFORMATION

Tip:

For a better overview and to make work easier, it is advisable to open each charging station in a separate tab of the browser in order to add these stations to a charging point group in charge management.

- Assign a "Hostname" under "Settings > Network".

⇒ "Hostname" is displayed in the corresponding tab.

Set up network

Integrate your charging station into a network here to prepare features like backend, remote access or load management.

Hostname

Obtain an IP address automatically?

IPv4 address

Subnet mask

DNS server address

IPv4 gateway address

Example: "Controller", "Responder 1", "Responder 2", etc.

Set up load management

Parameterize here how this charging station or a charging cluster handles limited power.

Load management mode?

Modbus TCP/IP

Activate enabling contact

1. Open tab with designated controller.
2. Click "Settings -> Charge management".
 - ⇒ "Set up charge management" opens.

Set up load management

Parameterize here how this charging station or a charging cluster handles limited power.

Load management mode

Maximum current for charging cluster

Adjustable maximum current for charging cluster

Unbalanced power limit

 Make sure you comply with local legal requirements.

Modbus TCP/IP

Activate enabling contact

Responders

+ Add element

3. Change the "Charge management mode" selection field to "Controller".
4. Adjust other parameters.
5. Apply changes.

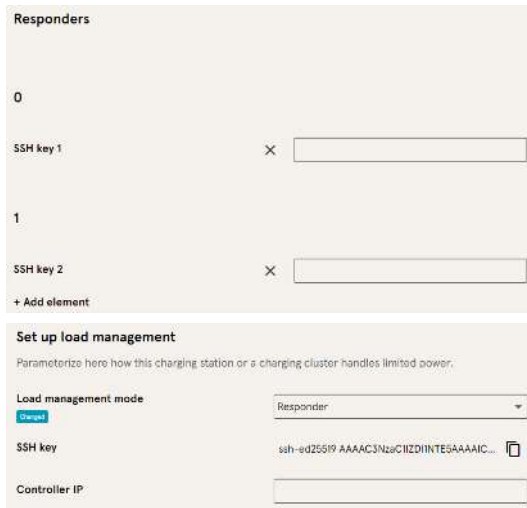

6. Click on "Add element" in the "Responder" section below.
 - ⇒ A consecutive number starting with 0 and an empty text field "SSH-Key X" appear.
7. Change tab to designated responder.
8. Click "Settings -> Charge management".
 - ⇒ "Set up charge management" opens.
9. Change the "Charge management mode" selection field to "Responder".

10. Enter the assigned controller IP in the "Controller IP" field.
11. Copy "SSH key" by clicking on the corresponding symbol.

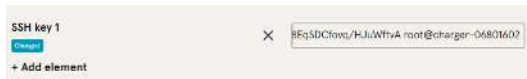

12. Switch back to the "Controller" tab.
13. Paste the copied SSH key into the "SSH

key 1" field.

14. Repeat the previous steps to set up additional responders.
15. After completing the setup, apply all changes, if not already done.



INFORMATION

After setting up charge management, each charging station must be restarted.

7.7.9.1 Modbus TCP/ IP

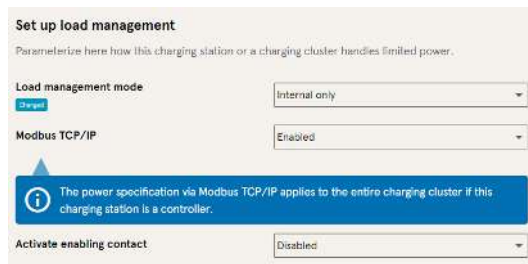

Depending on whether the charge management mode is set to "Internal only" or "Controller", either the individual charging station or the entire charging point group can be controlled by a higher-level energy manager.

Compleo has compatible energy

management systems in its programme.

If you want to integrate the charging station into your own energy management, we can provide you with our register specification.

7.7.9.2 Enabling contact

The "Enabling contact" function enables the connection of a system, e.g. a building management system, with which charging processes can be released via a control signal.

An optional enabling contact on the control board is described in the operating instructions for the charging station.

If the charging station is equipped with a ripple control receiver, an enabling contact is not activated.

7.8 Charging data

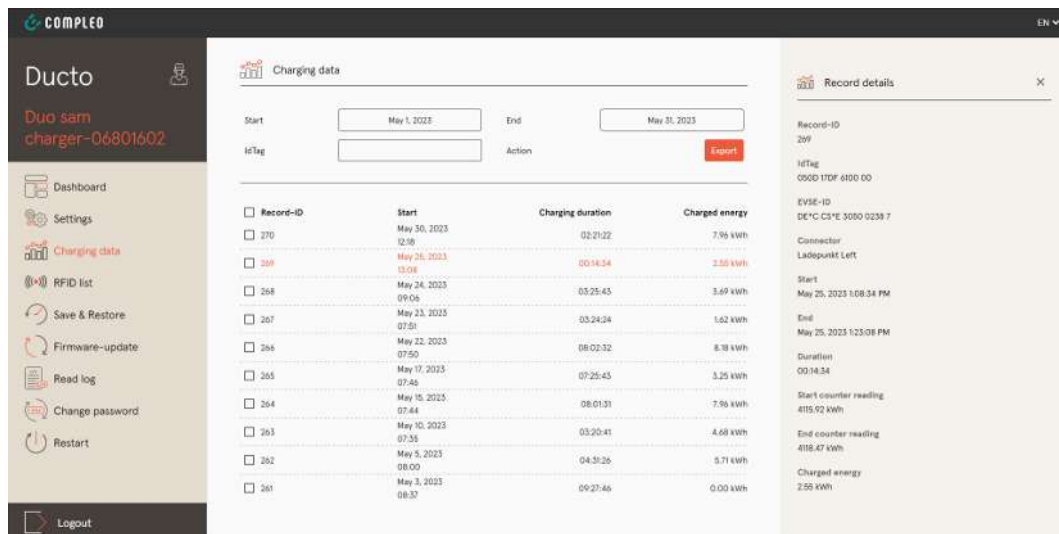

Record-ID	Start	Charging duration	Charged energy
270	May 30, 2023 12:18	02:21:22	7.95 kWh
268	May 26, 2023 13:08	00:14:54	2.55 kWh
268	May 24, 2023 09:06	05:25:45	3.49 kWh
267	May 23, 2023 07:51	03:24:34	1.62 kWh
266	May 22, 2023 07:50	08:02:32	6.78 kWh
265	May 17, 2023 07:49	07:25:45	3.25 kWh
264	May 15, 2023 07:44	08:01:31	7.55 kWh
263	May 10, 2023 07:35	03:20:41	4.68 kWh
262	May 5, 2023 08:00	04:31:26	5.71 kWh
261	May 3, 2023 08:37	04:27:46	0.00 kWh

Charging data can be viewed and exported via the charging data page without the need for a backend connection.

If required, the charging data can be filtered by time period and IdTag (number of the RFID card).

- Filter charge data as required.
 - ⇒ The filtered loading list appears.
- Click to select the desired charging process.
 - ⇒ Details of the selected charging process appear in the right-hand column.

7.8.1 Exporting charging data

Record-ID	Start	Charging duration	Charged energy
<input checked="" type="checkbox"/> 270	May 30, 2023 12:18	02:21:22	7.96 kWh
<input checked="" type="checkbox"/> 269	May 29, 2023 13:08	00:14:34	2.55 kWh
<input type="checkbox"/> 268	May 24, 2023 09:06	03:25:43	3.69 kWh
<input type="checkbox"/> 267	May 23, 2023 07:51	03:24:24	1.62 kWh
<input checked="" type="checkbox"/> 266	May 22, 2023 07:50	08:02:32	8.18 kWh
<input checked="" type="checkbox"/> 265	May 17, 2023 07:46	07:25:43	3.25 kWh
<input checked="" type="checkbox"/> 264	May 15, 2023 07:44	08:01:31	7.96 kWh
<input checked="" type="checkbox"/> 263	May 10, 2023 07:35	03:20:41	4.68 kWh
<input checked="" type="checkbox"/> 262	May 5, 2023 08:00	04:31:26	5.71 kWh
<input type="checkbox"/> 261	May 3, 2023 08:37	09:27:46	0.00 kWh

1. Filter and select charging data as required.
 2. Select export destination and file name.
 3. Click the "Export" button.
- ⇒ File with charging data is created in CSV format.

7.9 RFID list

RFID units can be displayed, created, grouped and filtered via the "RFID list" page. The list of RFID units can be exported and imported as required.

7.9.1 Teach-in mode

1. Click the "Teach-in mode" button to "On".

⇒ Each RFID unit is automatically registered by presenting it in front of the RFID sensor and is given a standard validity period as long as the timeout window is open. (See "Charging with RFID card" in the Chapter 7.7.8 *Offline operation, page 61*)

7.9.2 Adding an entry

1. Click the "Add entry" button.
- ⇒ Parameter list for entries opens in the right-hand column.

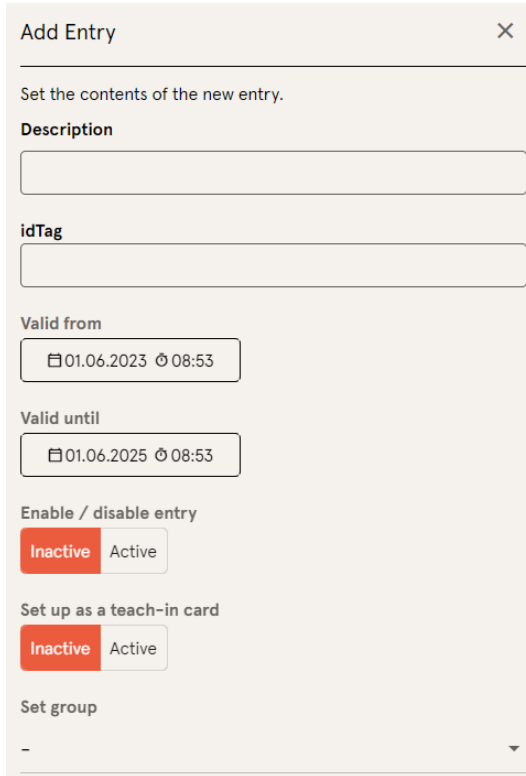

2. Enter the name of the RFID unit in the free text field.
3. Enter the idTag of the RFID unit in the free text field.
4. Specify validity period.
5. Activate/deactivate entry as required.

Optional: Set up as a teach-in card

After activating this function, teach-in mode can be started without Ducto by presenting the teach-in card.

This card can no longer be used to start or end a charging process.

7.9.3 Groups

This function can be used to summarise idTags in groups.

Members of this group have the same authorisations, e.g. a charging process triggered via RFID can be ended with another RFID unit from the same group.

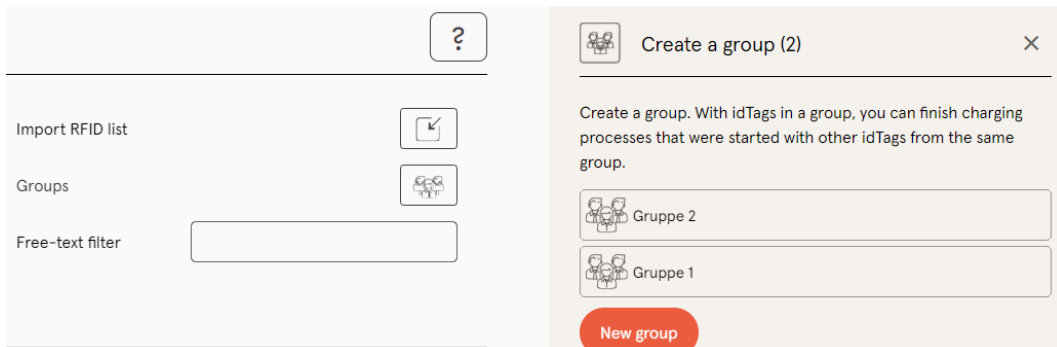

1. Click on the "Group" button in the centre column.
 - ⇒ The detailed menu in the right-hand column opens.
2. Add existing idTags to an existing group or combine them into a new group.

7.10 Save & restore

The current configuration can be saved via the "Save & restore" page in order to restore it later or transfer it to other charging stations.

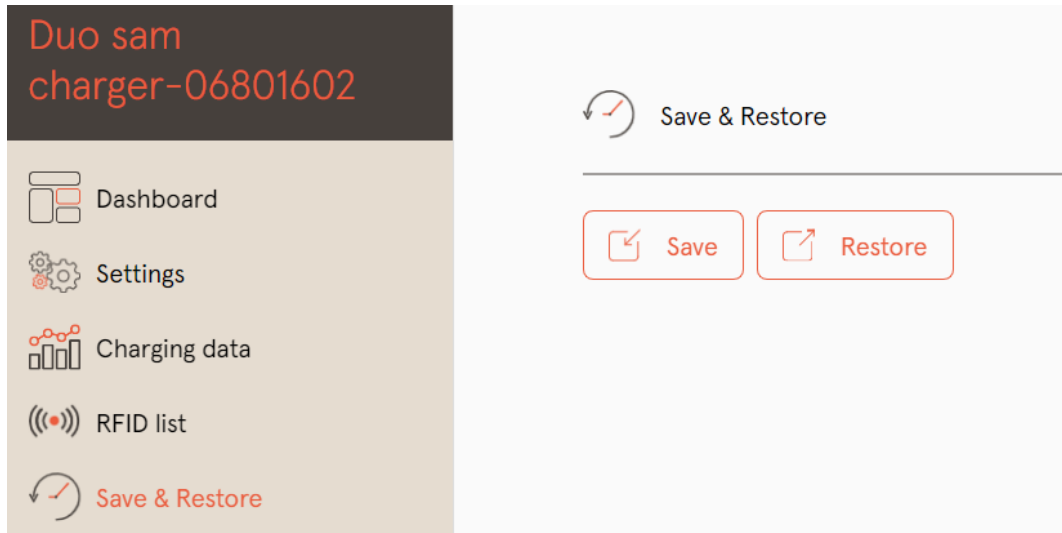

7.10.1 Save

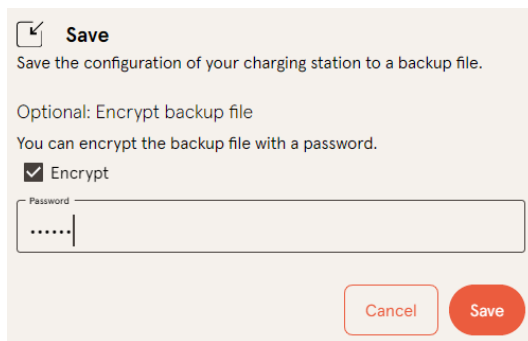

 A113C42001.11_0015615_230602.config

1. Click the "Save" button in the centre column.

- ⇒ The "Save" detail menu opens in the right-hand column.
- 2. Assign an optional password and click the "Save" button.
 - ⇒ Configuration file is generated and saved in the download directory of the connected computer.
 - ⇒ By default, the file name is made up of the article number, serial number and storage date (YYMMDD).
- 3. Store the configuration file in a safe place.

7.10.2 Restore

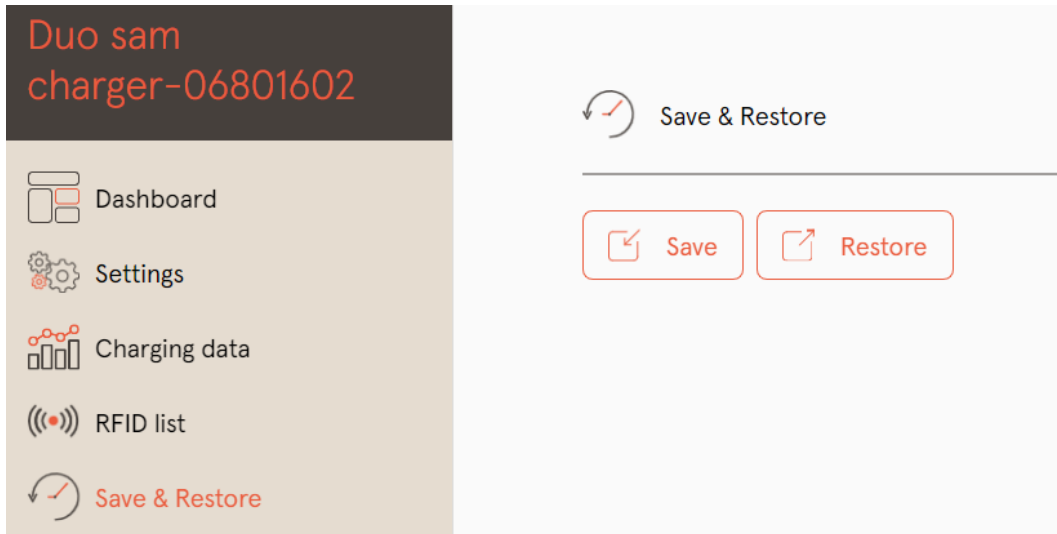

1. Click the "Restore" button in the centre column.
 - ⇒ The "Restore" detail menu opens in the right-hand column.

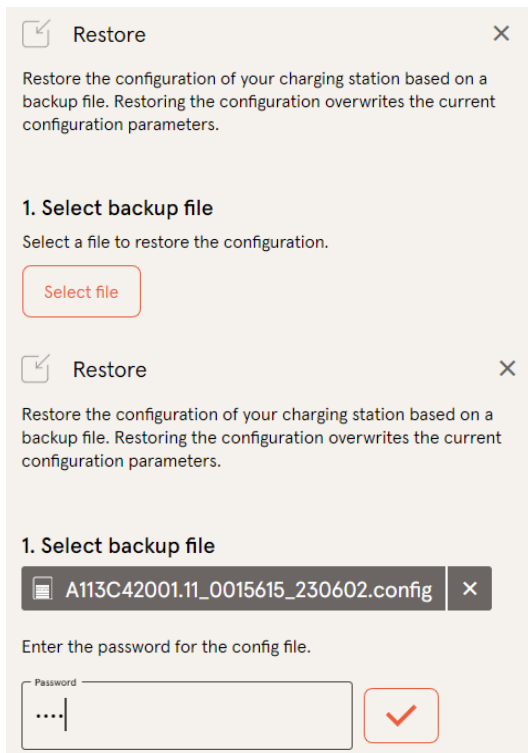

2. Select the desired configuration file.
3. Enter optional password.
4. Confirm with the "Tick" button.
 - ⇒ Configuration file is loaded.

2. Check parameter
 Check whether the values from the backup file correspond to the desired values. You can change the values from the backup file manually.

Important parameters

Hostname
 Config > Network

Current value
 charger-06801602 Retain?

New value

5. Check listed parameters.
6. Change or retain parameters.
7. Save all changes.
8. Restart the charging station.

7.10.3 Resetting to factory settings



NOTICE

Reset to factory settings not possible

There is no hardware- or software-based option for resetting to factory settings.

- Save the current configuration after each successful commissioning.
- Contact helpdesk@compleo-cs.com if the charging station can no longer be accessed via Ducto.

7.11 Firmware update

Firmware updates are issued as an automatic roll-out with an existing backend connection.

Firmware updates are also available in the Compleo Partner Portal or on request from your Compleo contact person.

7.11.1 Performing a firmware update

1. Enter the installed firmware and client version on the "Firmware update" page.
2. Check Compleo Partner Portal for new versions.
3. Download and save the new version file.
4. Click the "Select file" button and select the downloaded version file.

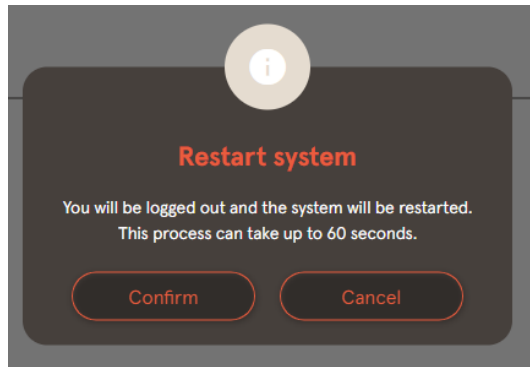

5. Confirm the request to restart the system.
- ⇒ The system is restarted. This process may take a few minutes.

7.12 Reading out log data

The "Read out log" page can be used to summarise, download and analyse log data over a period of up to 14 days.

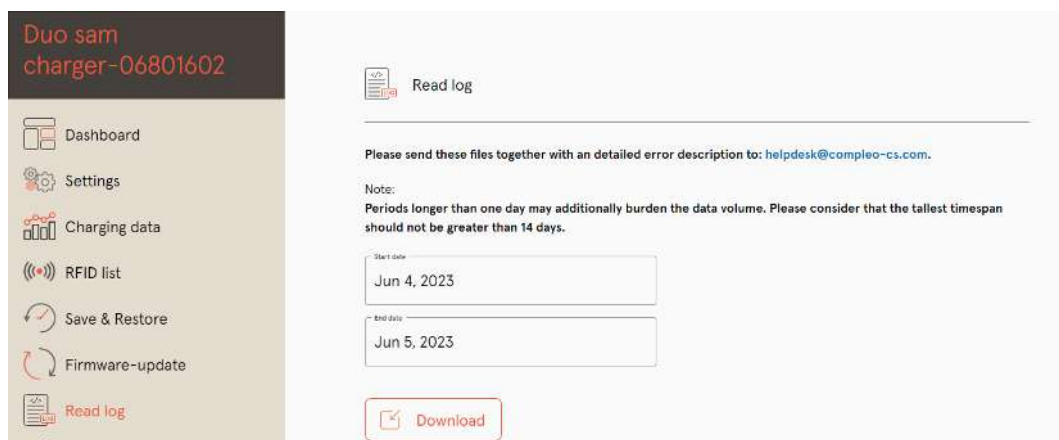

1. Select the desired period.
2. Click the "Download" button.
 - ⇒ Log data file is generated and saved in the download directory of the connected computer.
3. Send log data file including any detailed error description to helpdesk@compleo-cs.com.
 - ⇒ Compleo Helpdesk creates a service ticket and contacts the sender.

7.13 Changing the password

An individual password can be set on the "Change password" page.

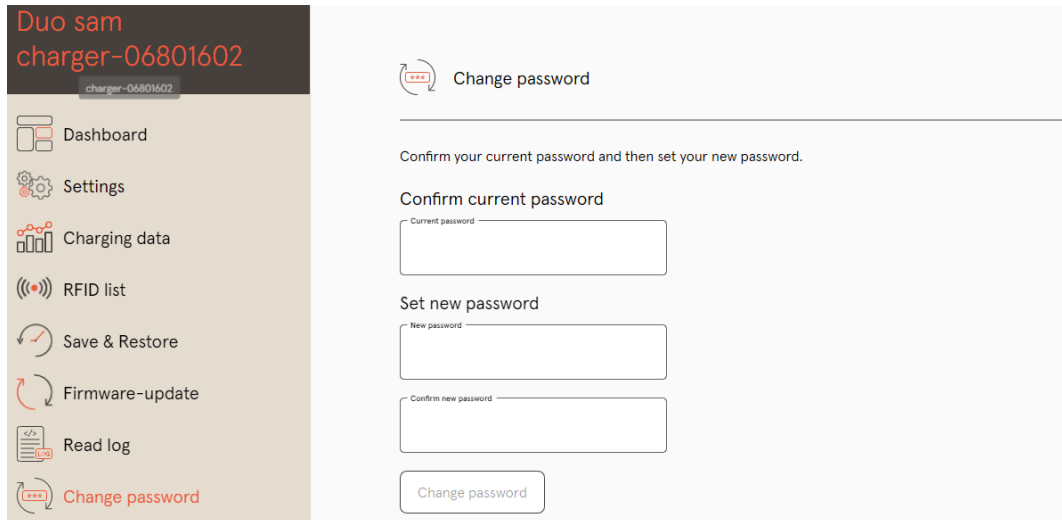

Compleo recommends changing the initial password for security reasons.



INFORMATION

If you forget the password, please send an e-mail to [helpdesk@ compleo-cs.com](mailto:helpdesk@compleo-cs.com) with the serial number of the charging station.

7.14 Parameter list

The list of all parameters including description, default value and access right is documented separately together with the OCPP GetConfiguration.

The current documentation is also included in Ducto for each parameter.



INFORMATION

Compleo provides the "OCPP GetConfiguration" documentation on request.

7.15 Restart

The system can be completely restarted via the "Restart" page.

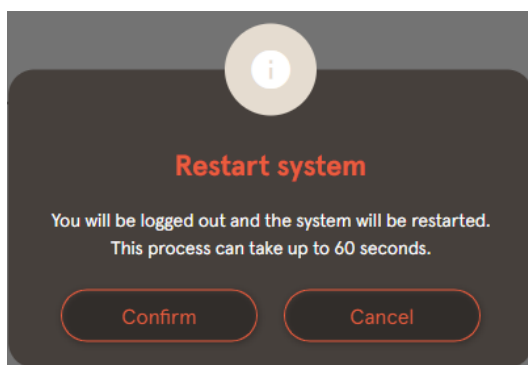

1. Click the "Confirm" button.
 - ⇒ The restart takes place and requires approx 60 s.
 - ⇒ After a successful restart, the dashboard opens automatically, provided that the IP address has not been changed.
 - ⇒ Active charging processes are resumed.

INFORMATION

Compleo recommends a restart as an early troubleshooting measure if the charging station is in a fault state that is difficult to identify.

7.16 Troubleshooting information

The following list describes error patterns that are primarily based on a faulty configuration.

Error pattern	Error clearance information
Ducto is not accessible	<ol style="list-style-type: none"> 1. Check network connection 2. With a fixed IP address: Check the IP address of the laptop's Ethernet port 3. With an automatic IP address: Search for charging station in the router interface
Password does not work	Inform helpdesk@compleo-cs.com
Backend connection is not established	<ol style="list-style-type: none"> 1. Check backend URL 2. Via SIM card: <ul style="list-style-type: none"> – Check whether the modem is activated – Check APN data 3. Via LAN: <ul style="list-style-type: none"> – Check network connection – Check whether AuthorisationKey is stored – When automatically determining the IP address, check whether the router has an Internet connection
Charging station does not charge	<ol style="list-style-type: none"> 1. Check currents 2. Check charge management configuration 3. Check authorisation mechanisms <ul style="list-style-type: none"> – Check backend connection – Check RFID list 4. Notify a qualified electrician

7.17 DUCTO Guide

Further information about DUCTO:

https://www.compleo-charging.com/fileadmin/Documentcenter/Ducto/Ducto_Guide.pdf

8 Operation

This chapter explains the general use of the charging system. The charging processes at the charging systems can be started and stopped by different authorisation methods. Depending on the charging system and product scope, the following forms of operation and authorisation are possible:

"Charge for free"

With the "Charge for free" method, a charging process is started or stopped at a charging system without special authorisation. The charging process is started as soon as a charging cable has been connected to the charging system and/or the vehicle. The charging process can only be terminated at the vehicle.

RFID

With the "RFID" method, a charging process is started or stopped at a charging system using a card or chip. The charging process is started as soon as authorisation has been successfully completed and a charging cable has been connected to the charging system and/or the vehicle.

Giro-e:

With the "Giro-e" method, a charging process is started on a charging system by means of a Giro card and then confirmed or terminated. The charging process is started as soon as authorisation has been successfully completed and a charging cable has been connected to the vehicle.

App on smartphone/tablet or website

With the "App on smartphone/tablet or website" method, a charging process is started or ended at a charging system by means of an App or a website.

The App is used to select the charging system, the charging point and the tariff.

The charging process is started as soon as a charging cable has been connected to the vehicle.

The display complying with weights and measures regulations shows an ID number assigned to the charging process.

Depending on the provider, billing takes place via a corresponding payment platform (e.g. PayPal or invoice).

Information on which App is necessary and how to operate the App can be obtained from the operator of the charging system.

Payment terminal:

The charging process is started at a charging system using a debit card, credit card, Google Pay or ApplePay and then confirmed or ended. The charging process is started as soon as authorisation has been successfully completed and a charging cable has been connected to the vehicle.

8.1 Charging process

The eTower 200 charging system has two DC charging interfaces.

Two parallel charging processes are possible at the DC charging interfaces. During a charging process, the plug is locked in the vehicle.

If a ventilation function is requested from the vehicle, the charging system interrupts the charging process.



INFORMATION

If the power supply is interrupted, the station is set to a safe state. The charging processes are terminated.

Re-authorisation is required to start a charging process.

8.1.1 Overview of the charging system

If no charging process has been started at the charging system, any one of the two charging points can be selected for a charging process.

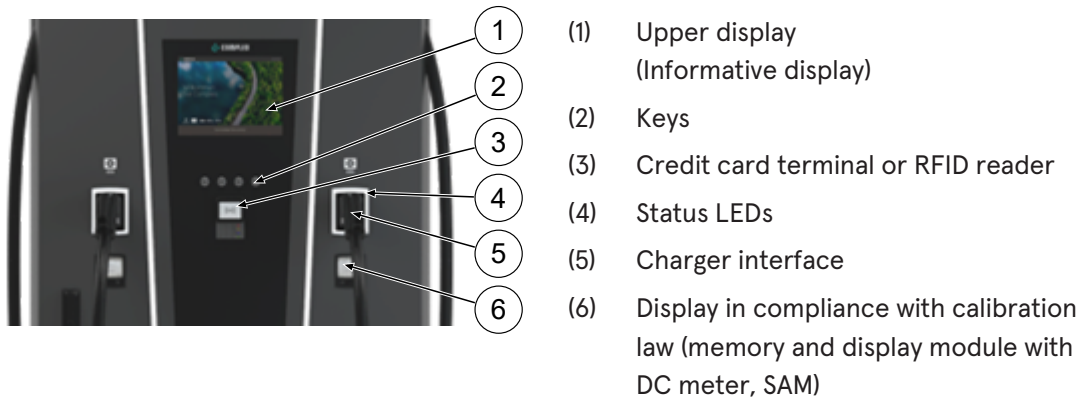







INFORMATION

The main display is a purely informative display, it has no operating function.

8.1.2 Meaning of the status LED colours

The following charging state display explains the colour states and the possible colour changes of a charging system with status LEDs:

LEDs indicator lights		
	LED: "Off"	<ul style="list-style-type: none"> - The charging system is in standby mode. <ul style="list-style-type: none"> - Authorisation can be carried out.
	LED: "green"	<ul style="list-style-type: none"> - The charging system indicates readiness for operation. (following successful authorisation). <ul style="list-style-type: none"> - A charging process can be started.
	LED: "blue"	<ul style="list-style-type: none"> - The charging system indicates a charging process. <ul style="list-style-type: none"> - The charging process can be maintained or terminated.
	LED: "red"	<ul style="list-style-type: none"> - The charging system indicates an error state. <ul style="list-style-type: none"> - A charging process cannot be started.

LED colour change		
	LED: "green-blue"	<ul style="list-style-type: none"> - The charging system indicates the start of a charging process.
	LED: "blue-green"	<ul style="list-style-type: none"> - The charging system indicates the end of a charging process.

LED flashing indicator		
	LED: "flashes green"	<ul style="list-style-type: none"> - The charging system is expecting for an action.

8.1.3 Acoustic signals

In the following table the possible acoustic signals are listed and explained:

Acoustic signals	
1 x short	Sounds when the RFID card is presented and indicates "Card read".
2 x short	This signal requires user interaction: <ul style="list-style-type: none"> - Present card for authorisation or - Plug the charging cable into the charging system and car
1 x long	Authorisation timeout: Sounds if user interaction has not occurred within a certain time.
2 x long	The charging system is in an error state. <ul style="list-style-type: none"> - If there is a display, note the error message.

8.1.4 Authorisation options

The following means of authorisation/payment are available:

- Contactless, payment without registration: Debit card, credit card
- Payment with charging contract: RFID card
- Payment on website without registration: Google Pay, ApplePay

eTower 200
22.05.2024

Authorization | Right plug

To start the charging process, use one of the payment methods shown below.



Debit, credit card,
smart device

Charging without contract
€0,79 per kWh



Smartphone,
scan QR code

Charging without contract
Price according to provider



Charging card,
charging app

Charging with contract
Price according to contract

Informative display. Plus usage fee €0,12 per min. from 180 minutes. Check the information in the display module of the charging point. After successful authorization, an amount will be reserved in your account. With your authorization you accept to receive a digital receipt at <https://ev-beleg.de>.

✕ Cancel
🗣️ Language



INFORMATION

Depending on the configuration and equipment, it is possible that not all of the listed authorisation/payment methods are available.

8.1.4.1 Authorisation

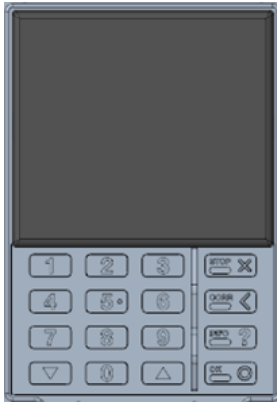

Contactless without registration/with charging contract

1. Hold the means of payment in front of the display of the credit card terminal.
 - ⇒ The display of the credit card terminal and the upper display (information display) show the successful authorisation.
 - ⇒ The upper display shows tariff conditions and the charging point.
 - ⇒ The status LED indicates readiness for operation.

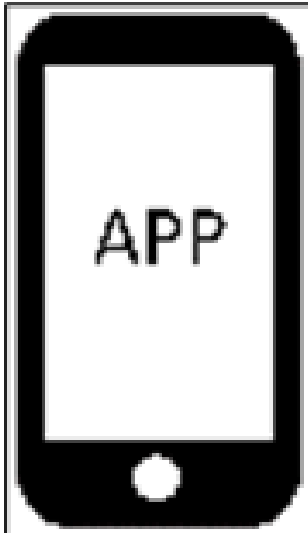

Payment on website without registration

1. Download and install app for smartphone or tablet or start web interface.
2. Follow the instructions of the app or web interface for the authorisation process.
 - ⇒ The display and the status LED indicate readiness for operation.

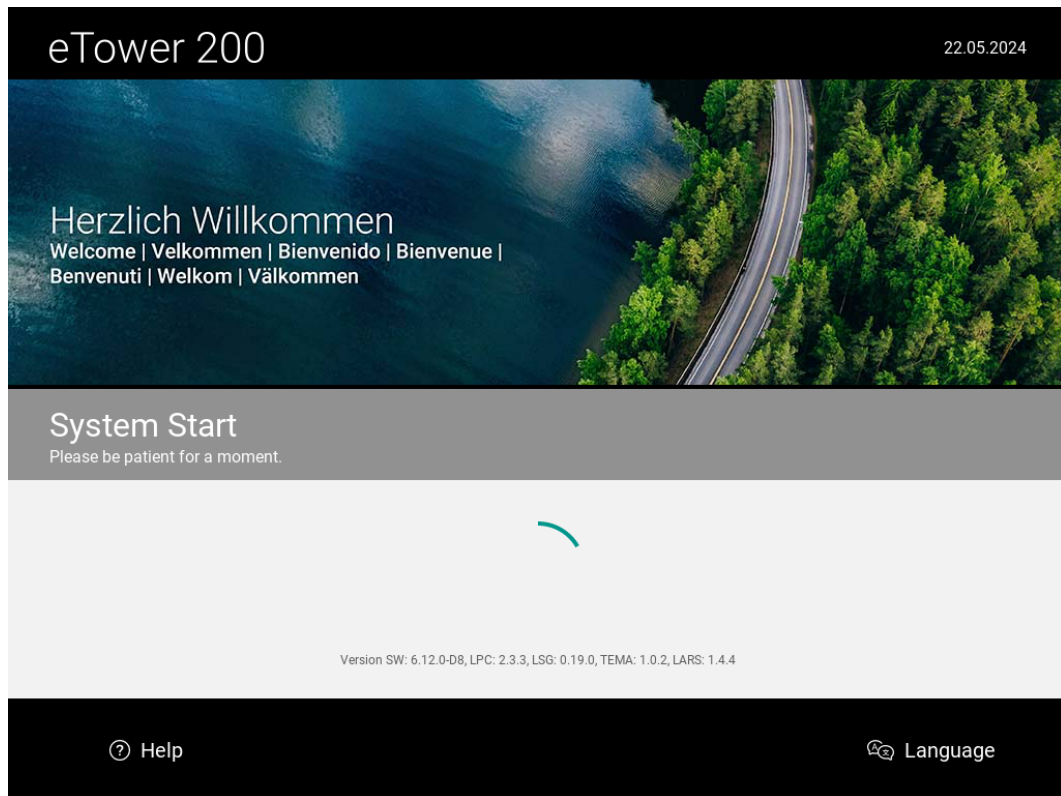

INFORMATION

The tariff conditions shown do not apply to charging contracts.

8.1.5 Connecting the charging cable

Before plugging in the charging cables, check that the status LED of the charging point is green.



1. Plug in the charging cable in the socket of the vehicle.
⇒ Charging process is started.

8.1.6 Starting the charging process

The charging process starts automatically after the existing authorisation method has been successfully carried out and the charging system and vehicle have been connected to the charging cable.

During charging, the plug is locked in the charging system and in the vehicle.

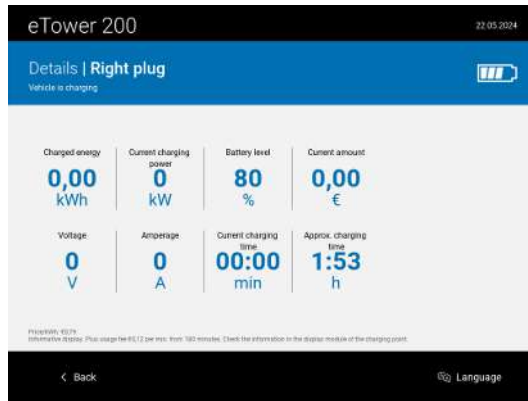

- The display and the status LED indicate the start of the charging process.
- Details of the charging process are displayed.



INFORMATION

The binding charging data (in compliance with calibration law) is shown on the display of the storage and display module (SAM) on the respective side of the charging system.

8.1.7 Ending the charging process

The charging process stops automatically after the existing authorisation method has been successfully executed again.

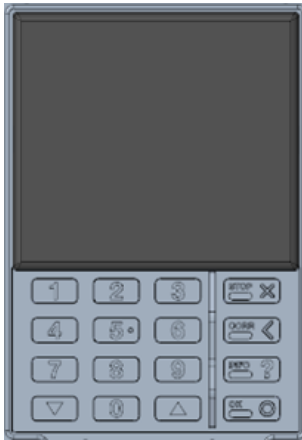

Contactless without registration/with charging contract

1. Hold the means of payment in front of the display of the credit card terminal.

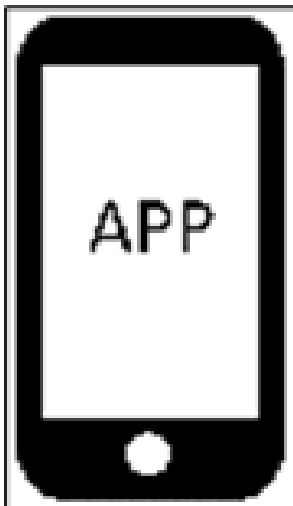

Payment on website without registration

1. Follow the instructions of the app or web interface for finishing the charging process.
 - ⇒ The display and the status LED indicate the end of the charging process.

eTower 200
22.05.2024

End | Right plug

Please put the right plug back into the parking position of the charger.



Charged energy	Current amount	Battery level
0,00	0,00	24
kWh	€	%

Price/kWh: €0,79
 Informative display. Plus usage fee €0,12 per min. from 180 minutes. Check the information in the display module of the charging point.

🔗 Help
🗨️ Language

2. Pull out the charging cable from the socket of the vehicle.
- ⇒ Charging is finished.

9 Malfunctions

9.1 Internal errors

- If the display shows "Internal error", the charging station must be disconnected from the mains.

9.2 Residual current circuit breaker (RCCB)

In the event of a residual current, the residual current circuit breaker trips.

To switch on again, proceed as follows:

1. Eliminate the cause of the error.
 2. Reactivate the residual current circuit breaker using the slider on the RCCB.
- ⇒ The charging system is ready for operation again.



INFORMATION

Only applies to charging systems with built-in residual current circuit breaker (RCCB).

9.3 Circuit breaker (MCB)

In the event of an overcurrent, the affected circuit breaker trips and the charging system is switched off.

To switch on again, proceed as follows:

1. Eliminate the cause of the error.
 2. Reactivate the circuit breaker at the sub-distribution.
- ⇒ The charging system is ready for operation again.

10 Troubleshooting information

Charging systems equipped with a display show an error code on the display in the event of an error.

If several errors occur at the same time or in combination, the respective error codes are shown one after the other on the display.

10.1 About this information

Column name	Explanation
Designation	String that is sent to the back-end when the charging station is in online mode.
Abbreviation	Symbol that is shown individually or in combination with other symbols on the display of the charging station depending on the status.
Error clearance information	Description of the error and information on troubleshooting.

10.2 Scope of application

Firmware > 5.X

10.3 OCPP 1.6

Designation	Abbreviation	Error clearance information
GroundFailure	B	The RCD switch, the circuit breaker or the 6mA sensor of the charging point has tripped. Requires inspection by qualified electrician.
InternalError	D	Internal hardware or software component error. Requires inspection by qualified electrician.
OverVoltage	E	The voltage has risen above an acceptable level. Requires inspection by qualified electrician.
PowerMeterFailure	F	Error when reading the meter. Check SAM or meter for correct function and report the malfunction.
PowerSwitchFailure	G	Contactors fault. Requires inspection by qualified electrician.
UnderVoltage	I	The voltage has fallen below an acceptable level. Requires inspection by qualified electrician.
ConnectorLockFailure	-	Error when locking or unlocking the plug. Check whether the plug is properly connected.
OverCurrentFailure	-	The vehicle has drawn more current than specified over a longer period of time.

Unused: EVCommunicationError, HighTemperature, ReaderFailure, WeakSignal

10.4 Compleo-specific

Designation	Abbreviation	Error clearance information
IsolationWarning	K	Insulation problems have occurred before or during a charging process. Requires inspection by qualified electrician.
IsolationError	L	Insulation problems have occurred before or during a charging process. Requires inspection by qualified electrician.
DoorOpen	M	The door contact signals that the door has been opened. Close the door. If this condition is permanent, an inspection by a qualified electrician is required.
DoorClosed	N	The door contact signals that the door has been closed. No action required.
Inoperative	O	The charging point is not available because a resource, such as the power module, is occupied by another charging point. Requires inspection by qualified electrician.
FuseError	P	A circuit breaker switch has triggered. Requires inspection by qualified electrician.
TemperatureSensorMissing	Q	The temperature sensor does not provide any values. Requires inspection by qualified electrician.
AutomaticRcdTestRunning	T	Automatic RCD test is running. No action required.
RCSensorTestRunning	W	Test of the 6mA sensor test is running. No action required.
samTransactionMemoryFull	4	SAM has no more free memory for new charging processes. SAM must be replaced by a qualified electrician.
samEVSEIDMemoryFull	5	SAM has no more free memory for new configuration parameters. SAM must be replaced by a qualified electrician.
samFirmwareCorrupted	6	The SAM firmware checksum check failed. If this condition is permanent, SAM must be replaced by a qualified electrician.

Designation	Abbreviation	Error clearance information
samNoTouchControllerComm	7	The connection to the SAM buttons is faulty. Requires inspection by qualified electrician. If this condition is permanent, SAM must be replaced by a qualified electrician.
samNotInitialized	8	SAM initialisation failed. If this condition is permanent, SAM must be replaced by a qualified electrician.
samInternalError	9	SAM reports an internal error. SAM must be replaced by a qualified electrician.
UnlockPlugFailure	a	The plug could not be unlocked. The locking unit of the charging point must be checked by trained personnel and replaced if necessary.
OutletCloseError	b	The sliding cover could not be closed. The locking unit of the sliding cover must be checked by trained personnel and replaced if necessary.
LPCCommunicationError	c	Communication between the charging point controller and the charging station controller is faulty. The respective connection must be checked by trained personnel and replaced if necessary.
CableError	d	An unauthorised charging cable was detected. Use another charging cable.
RCSensorTestError	e	The 6mA sensor test failed. Requires inspection by qualified electrician.
PowerMonitoringError	f	The charging point controller has detected a mains failure. Requires inspection by qualified electrician.
ADCError	g	The charging point controller has detected an ADC error. Requires inspection by qualified electrician.
ShortCircuitError	h	The charging point controller has detected a short circuit between CP and PE. Requires inspection by qualified electrician.
LPCOverVoltageError	i	The charging point controller has detected an overvoltage. Requires inspection by qualified electrician.
LPCHighTemperatureError	j	The charging point controller has detected a temperature that is too high. Requires inspection by qualified electrician.
LPCSelftestError	k	The self-test of the charging point controller has failed. Requires inspection by qualified electrician.
AutomaticRcdTestFailed	m	The automatic test of the RCD failed. Requires inspection by qualified electrician.

Designation	Abbreviation	Error clearance information
LPCTemperatureSensorError	n	The charge point controller reports a temperature sensor error. Requires exchange by qualified electrician.
CurrentSensorFailure	o	The charge point controller reports current sensor failure. Requires inspection by qualified electrician.
PolarityProtectionError	p	The charge point controller reports that the phases are connected with reversed polarity. Requires inspection by qualified electrician.
samCompensationsParametersMismatch	q	Compensation parameters in SAM and the meter do not match. Requires inspection by qualified electrician.
samCompensationTariffMismatch	r	Selected tariff in the meter does not correspond to the one reported as active by the meter. Requires inspection by qualified electrician.
samMeterIdMismatch	s	The SML ID of the connected meter does not correspond to that of the meter coupled to the SAM. Requires inspection by qualified electrician.
AutomaticRcdTestSuccess	-	Automatic RCD test successful. No action required.
AutomaticRcdTestTripFailure	-	Automatic RCD test failed. Requires inspection by qualified electrician.
AutomaticRcdReset ContactorTestFailed	-	The cause of the failed RCD test has not been rectified. Requires inspection by qualified electrician.
AutomaticRcdResetSuccess	-	The cause of the failed RCD test has been rectified. No action required.
OutletOpenError	-	The socket could not be opened. Requires inspection by qualified electrician.
RCSensorErrorDuringCharge	-	The 6mA sensor triggered during a charging process. Inspection by a qualified electrician is required if the fault occurs frequently.

11 Maintenance

Careful and regular maintenance ensures that the functional condition of the charging system is maintained. Only a regularly checked and maintained charging system is able to guarantee maximum availability and reliable charging processes.

The maintenance intervals depend on the prevailing operating conditions, such as the frequency of use and environmental influences such as the degree of contamination.

We recommend a cyclically recurring inspection according to the maintenance plan. In special cases, the cycles can be shorter.



DANGER

Danger due to electric current

Touching live parts will result in electric shock with serious injury or death.

- Work on electrical components may only be carried out by a qualified electrician and in accordance with electrotechnical regulations.
- Ensure absence of voltage and take suitable protective measures.



WARNING

Danger due to improper maintenance

Improper performance of work can lead to serious injuries and damage to property.

- Only allow work to be carried out by trained specialist personnel.
- Meet all safety requirements before maintenance.

11.1 Maintenance plan

Interval	Component/location	Maintenance work
Every 6 months	Residual current circuit breaker	Check with test button.
	Surge arrester	Visual inspection.
Yearly	Location	Visual inspection, e.g. for distances to objects (bushes, electrical installations ,etc.), attachment.
	Electrical components	Visual inspection, e.g. cables, lines, screw connections, plugs, RCD, MCB, display, LED, display, surge protection.
		Metrological verification according to test report, see Annex.
		Check for function, e.g. RCD (test button), MCB, IMD.
	Mechanical components	Visual inspection, e.g. housing, paint, foils, covers.
		Check for function, e.g. door and closing mechanism; check parking position.
Charging system	Check for function, e.g. start and stop of a charging process at all charger interfaces.	
Wear parts	Replace, e.g. filter mats (only for active cooling).	
As required	Charging system	Clean the inside and outside of the housing.



INFORMATION

The appendix to this manual contains a test report, the test steps of which are derived from the German standards DIN VDE 0100-600 and DIN VDE 0105-100.

Deviating or supplementary national regulations must be observed!

See chapter 13.3 *Commissioning and test reports, page 100.*

11.2 Replacing the filter mat at the air inlet

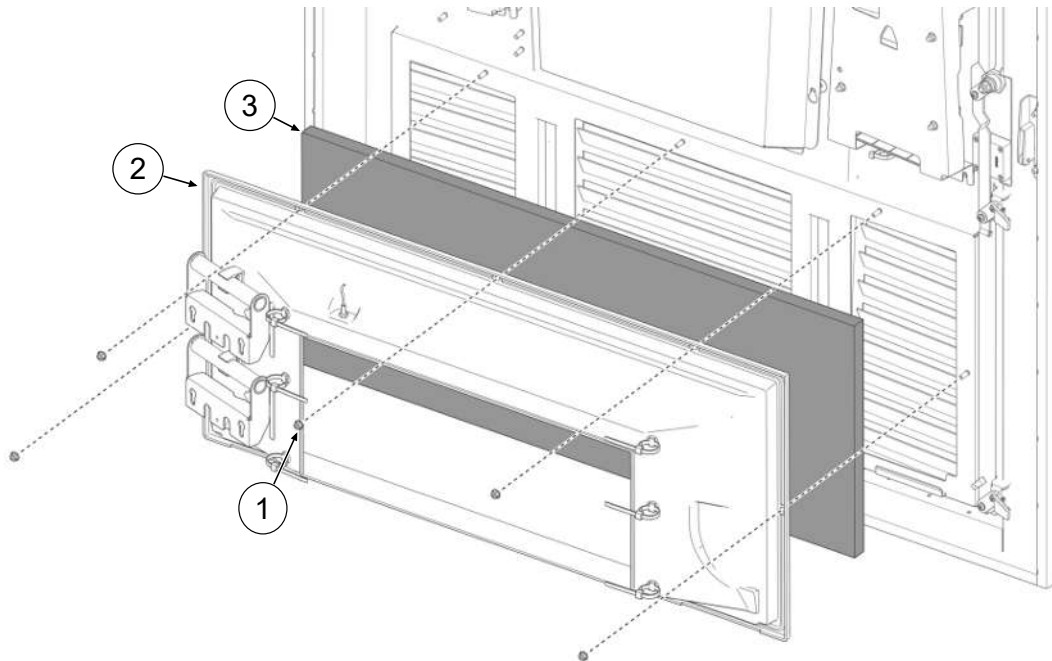

1. Loosen the 5 nuts (1) of the filter box.
2. Remove the filter box (2). Make sure that no connections are damaged.
3. Replace filter mat (3).
4. Replace the filter box and tighten with nuts.

11.3 Replacing the filter mat at the air outlet

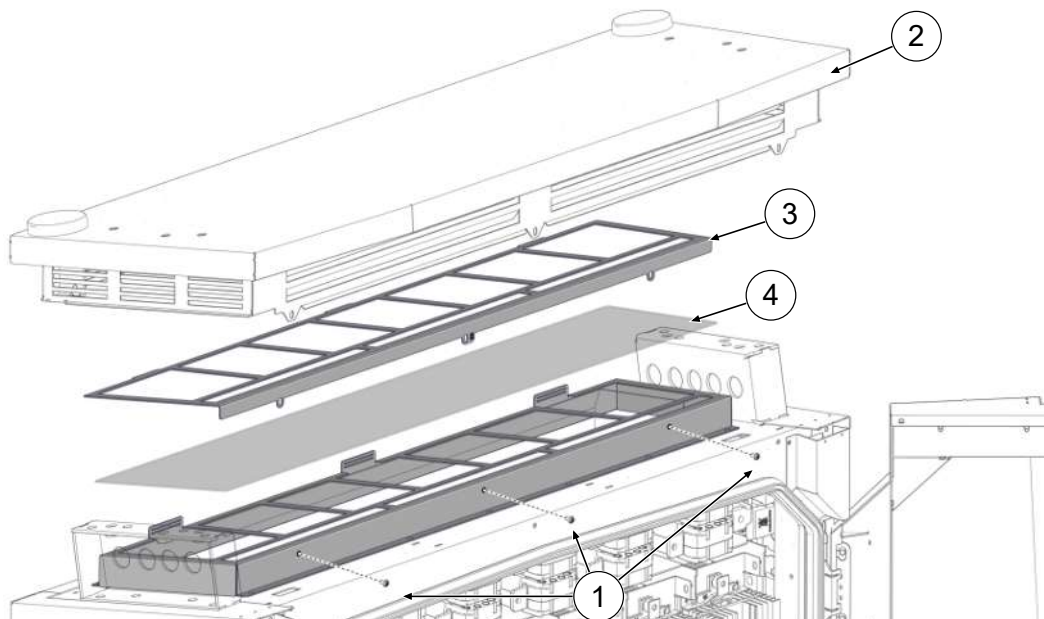

1. Unscrew the screws of the roof cover (1).
2. Tilt the roof (2) backwards and secure it.
3. Remove the filter clamping plate (3).
4. Replace filter mat (4).

5. Replace the filter clamping plate, tilt the roof back and screw tight.

11.4 Cleaning

The components inside the charging system need to be cleaned according to the assessment of an expert but this is not always necessary. Any necessary cleaning of the interior must only be carried out after consultation with the operator of the charging system. Cleaning may only be carried out by a properly and professionally instructed person and must never be carried out by a user.

Only materials and dry cleaning agents which are antistatic and do not damage the electrical or mechanical components may be used as cleaning agents for the interior. Only materials and agents that do not attack or damage the surface of the housing or any applied foiling or paintwork should be used as cleaning agents for the external housing. If chemical agents are used during cleaning, the work must be carried out outdoors or, if this is not possible, only in well-ventilated rooms.



DANGER

Danger due to electric current

Touching live parts will result in electric shock with serious injury or death.

- Only clean the charging system when it is switched off.
- Do not clean the outer housing with water jets, e.g. with a hose or a high-pressure cleaner.
- Do not clean the interior of the charging system with liquid cleaning agents.
- Do not clean any plugs in the charging system.

12 Decommissioning, dismantling and disposal

The decommissioning and dismantling of the charging system may only be carried out by a qualified electrician.

The national legal requirements and regulations must be observed.



DANGER

Danger due to electric current

Touching live parts will result in electric shock with serious injury or death.

- Work on electrical components may only be carried out by a qualified electrician and in accordance with electrotechnical regulations.
- Ensure absence of voltage and take suitable protective measures.

1. . Finish charging processes properly.
2. . Disconnect the charging system from the power supply.
 - Activate using the internally installed safety elements such as MCB, RCD and any installed main switch.
 - Release the upstream fuse element of the charging system.

Dismantling may only be carried out after it has been established that no voltage is present and suitable protective measures have been taken.

12.1 Disposal

The unit contains materials that can be recycled. To protect the environment and human health, disposal must be carried out in accordance with the laws of the country and the existing take-back organisations.

- Observe the requirements of the WEEE Directive 2012/19/EU.
- Dispose of the unit accordingly only via the take-back organisation.
- Dispose of dismantled components only via the take-back organisation.



NOTICE

Incorrect or negligent disposal causes environmental pollution.

- If you have any questions about environmentally friendly disposal, ask your specialist dealer or the manufacturer for information.

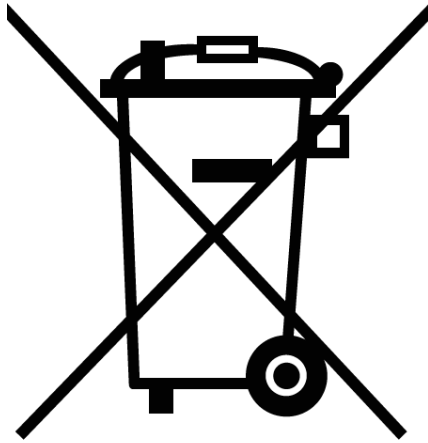

Disposal instructions

The symbol with the crossed-out dustbin indicates that this electrical or electronic appliance must not be disposed of with household waste at the end of its service life.

To return the product, contact the manufacturer or dealer.

The separate collection of waste electrical and electronic equipment is intended to enable the reuse, recycling or other forms of recovery of waste equipment and to avoid negative consequences for the environment and human health when disposing of hazardous substances that may be contained in the equipment.

13 Annexes

13.1 Unit dimensions

eTower200 dimensions

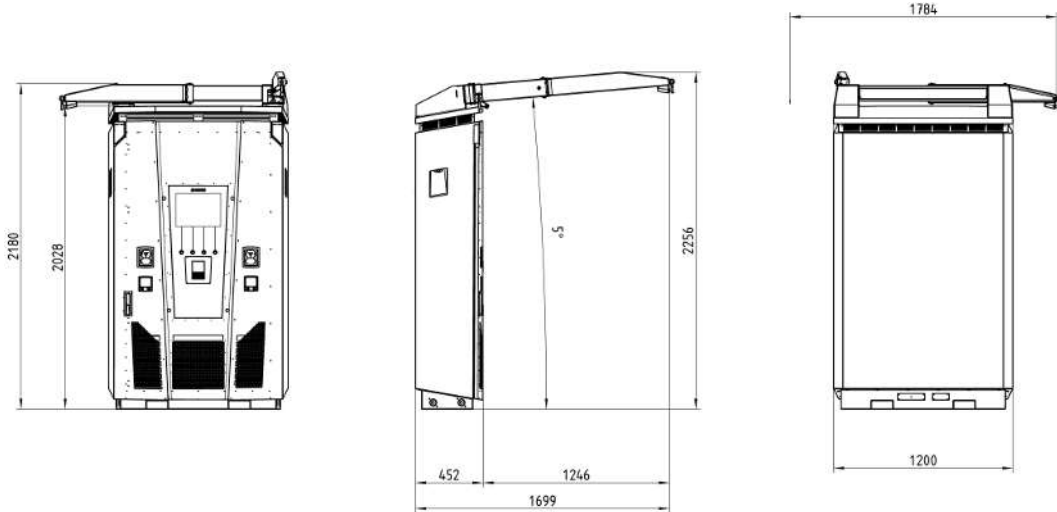

Concrete base dimensions

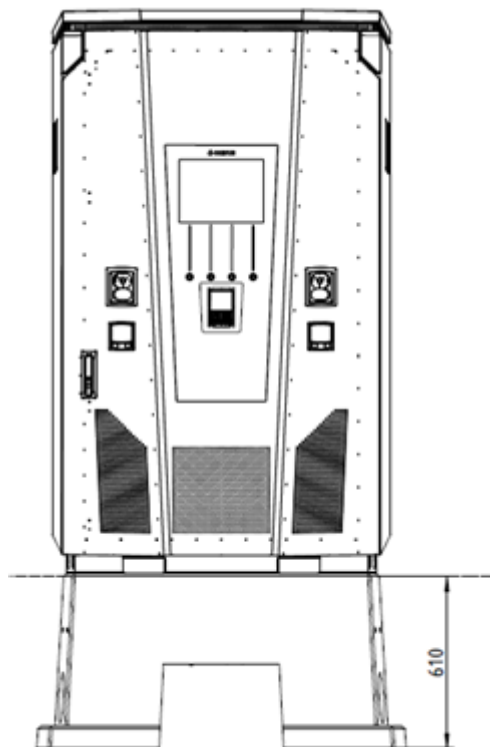

Opening angle of the door

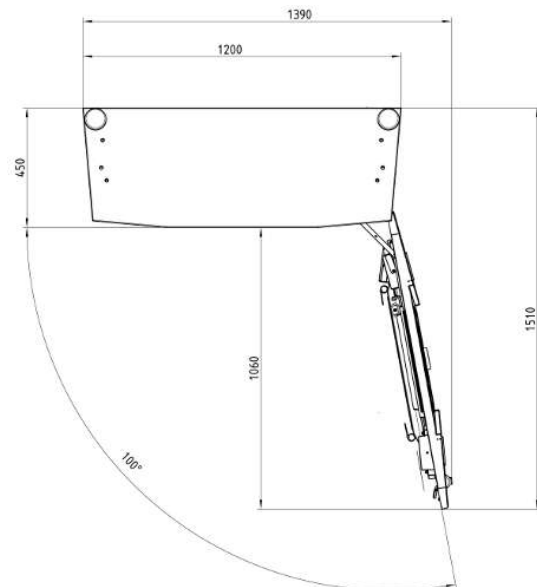

13.2 Data sheets for V-steel frame clamps

- V-steel frame clamp KM2G-F V90-120
- V-steel frame double clamp KV2HG/2/W30

See also

 [V-steel frame clamps \[► 96\]](#)

Type designation: KM2G-F V90-120

Article number: K2301092

Images



(Illustration similar)

Description

V-type steel-frame clamp for devices with V-shaped terminal lug

Features

Type:	KM2G-F V90-120
max. clamping range:	25 - 240 mm ²
Cross-section copper round solid:	25-150 mm ²
Cross-section copper round stranded:	25-240 mm ²
Cross-section copper sector solid:	25-240 mm ²
Cross-section copper sector stranded:	25-185 mm ²
Cross-section aluminium round solid:	25-150 mm ²
Cross-section aluminium round stranded:	25-240 mm ²
Cross-section aluminium sector solid:	25-240 mm ²
Cross-section aluminium sector stranded:	25-185 mm ²
Nominal torque:	32 Nm
Gültigkeit Querschnitt:	Cross section valid for thickness of terminal lug 3-5mm
Packaging unit:	3

Further developments of our products and technical changes are subject to change. Alterations, errors and errata constitute no claim for damages. Our valid sales terms and delivery conditions are available on our website <http://www.jeanmueller.de>

Printed at: 29.04.2024 / 14:20

Documents



Catalogue



3D-STEP



Catalogue Appendix





CE-conformity declaration



Drawings

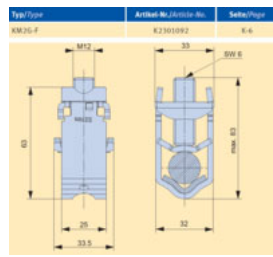

(Illustration similar)

Type designation: KV2HG/2/W30

Article number: K2302025

Images



(Illustration similar)

Description

V-Steel-frame clamp with connecting lug

Features

Type:	KV2HG/2/W30
max. clamping range:	120 - 185 mm ²
Cross-section copper round stranded:	120-185 mm ²
Cross-section copper sector stranded:	120-185 mm ²
Cross-section aluminium round stranded:	120-185 mm ²
Cross-section aluminium sector stranded:	120-185 mm ²
Nominal torque:	40 Nm
Twist-stop:	true
Packaging unit:	1

Further developments of our products and technical changes are subject to change. Alterations, errors and errata constitute no claim for damages. Our valid sales terms and delivery conditions are available on our website <http://www.jeanmueller.de>

Printed at: 03.05.2024 / 09:31

Documents



Catalogue



3D-STEP



Catalogue Appendix



CE-conformity declaration



Drawings

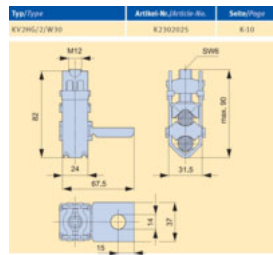

(Illustration similar)

13.3 Commissioning and test reports

See also

 DC-Prüfprotokoll_V1.9 [▶ 101]

Commissioning and test report for DC charging systems

Applicable for DC charging systems with **combined** operating and power unit (**one housing**):

Operator of the system:

Company/name:

Street:

Post code/town:

Telephone number:

Testing company:

Company/name:

Street:

Post code/town:

Telephone number:

Location of the system:
Date:
 Initial commissioning: according to DIN VDE 0100-600 (2017:06)

 Periodic inspection: according to DIN VDE 0105-100 (2015:10)

Deviating or supplementary national regulations must be observed!

1 General information

Pre-installation carried out by customer	<input type="checkbox"/> yes	<input type="checkbox"/> no
Pre-installation documentation available (pre-installation protocol)	<input type="checkbox"/> yes	<input type="checkbox"/> no

Designation of the test item:			
Serial number:			
Expiration of the calibration period (for version in compliance with calibration law)	KW/year		
Network form:	<input type="checkbox"/> TT	<input type="checkbox"/> TN-S	<input type="checkbox"/> TN-C
Local earthing available	<input type="checkbox"/> yes	<input type="checkbox"/> no	
Lightning protection concept recognisable at the site	<input type="checkbox"/> yes	<input type="checkbox"/> no	Point out the necessity to the operator!

1.1 Equipment-dependent specifications

Component	Not installed	Serial number	Counter reading in kWh
Charging point counter 1	<input type="checkbox"/>		
Charging point counter 2	<input type="checkbox"/>		
Component	Not installed	Type designation(s)	Comments
Overvoltage protection HMI	<input type="checkbox"/>		

2 Work before initial commissioning

INFO: Cut the cable insulation to length according to the installation instructions (failure to do so may result in a **FIRE HAZARD**)

Check of the cable glands (torque) and tensile test on cables in a de-energised state carried out? **Yes**
 No

2.1 Measuring and testing equipment used

Manufacturer	Designation	Serial number	Next calibration

3 Visual inspections

External visual inspection	Control panel (HMI)		Comments
	OK	NOK	
Housing condition	<input type="checkbox"/>	<input type="checkbox"/>	
Contamination	<input type="checkbox"/>	<input type="checkbox"/>	
Display disc counter/SAM	<input type="checkbox"/>	<input type="checkbox"/>	
Display disc controller	<input type="checkbox"/>	<input type="checkbox"/>	
Charging cable CCS	<input type="checkbox"/>	<input type="checkbox"/>	In the event of damage: Replacement only by certified repairer! (Conformity with law on weights and measures must be checked)
Charging cable CHAdeMO	<input type="checkbox"/>	<input type="checkbox"/>	
Charging socket AC	<input type="checkbox"/>	<input type="checkbox"/>	
Ram protection (if available)	<input type="checkbox"/>	<input type="checkbox"/>	

Internal visual inspection	Control panel (HMI)		Comments
	OK	NOK	
Components (RCD, contactor, MCB,...)	<input type="checkbox"/>	<input type="checkbox"/>	
Cabling	<input type="checkbox"/>	<input type="checkbox"/>	e.g. cable gland
General level of contamination	<input type="checkbox"/>	<input type="checkbox"/>	
Filter contamination level	<input type="checkbox"/>	<input type="checkbox"/>	
Humidity	<input type="checkbox"/>	<input type="checkbox"/>	
Corrosion	<input type="checkbox"/>	<input type="checkbox"/>	
Overvoltage protection (if available)	<input type="checkbox"/>	<input type="checkbox"/>	Visual display = green
Base filler applied	<input type="checkbox"/>	<input type="checkbox"/>	
Covers for active parts	<input type="checkbox"/>	<input type="checkbox"/>	

4 Metrological inspection (to be carried out once a year)

Test	Individual measurements	Limit value	Measured value	Comments	
Continuity of protective conductor	CCS	Low impedance Recommendation : <1Ω	Ω	Measurement from charging cable/charging socket to charging station feed-in	
	Type 2		Ω		
Equipotential bonding	Main equipotential bonding rail	Low impedance	Ω	Recommendation: <1Ω	
Insulation resistance without consumer (from supply point of charging system to charging plug, with fixed cable or charging socket)	L1-PE	≥1.0MΩ	MΩ	For charging systems with two charging points, disconnect one charging point by switching off one MCB and measure the other side before starting the measurement, then repeat this procedure on the other side. VDE 0100-600 Section 6.4.3.3 Reduce the measuring voltage to 250V when testing the active conductors with each other and repeat the test if Riso <1MΩ	
	L2-PE		MΩ		
	L3-PE		MΩ		
	N-PE		MΩ		
	L1-L2	≥1.0MΩ	MΩ		
	L2-L3		MΩ		
	L1-L3		MΩ		
	L1-N		MΩ		
	L2-N		MΩ		
L3-N	MΩ				
Mains voltage	L1-N	230V	V		
	L2-N	+/-10%	V		
	L3-N		V		
	L1-L2	400V	V		
	L2-L3	+/-10%	V		
	L1-L3		V		
Rel. voltage drop (calc. meas.)	<input type="checkbox"/> OK <input type="checkbox"/> NOK	Max. 5% up to supply point		Measurement of NSV - supply point output	
Error loop impedance Z_s	TN network	L1-PE	$Z_s \leq \frac{U_0}{I_a}$ U_0 = nominal AC voltage I_a = trip current (MCB/RCD)	<input type="checkbox"/> OK <input type="checkbox"/> NOK	VDE 0100-600 Section 6.4.3.7.1 Note 1: If residual current devices (RCDs) with $I_{\Delta N} \leq 500$ mA are used as shutdown devices, measurement of the fault loop impedance is generally not required.
		L2-PE		<input type="checkbox"/> OK <input type="checkbox"/> NOK	
		L3-PE		<input type="checkbox"/> OK <input type="checkbox"/> NOK	
	TT network	L1-PE	$Z_s \leq \frac{50V}{I_{\Delta N}}$ $I_{\Delta N}$ = rated differential current in A of the RCD	<input type="checkbox"/> OK <input type="checkbox"/> NOK	
		L2-PE		<input type="checkbox"/> OK <input type="checkbox"/> NOK	
		L3-PE		<input type="checkbox"/> OK <input type="checkbox"/> NOK	

		N-PE		<input type="checkbox"/> OK <input type="checkbox"/> NOK		
Residual current device RCD and DC sensor	AC Residual current, sinusoidal	Trip current $I_{\Delta N}=30\text{mA}$	$>15 \leq 30\text{mA}$		mA	
		Trip time $1x I_N$	$<300\text{ms}$		ms	
		Trip time $5x I_N$	$<40\text{ms}$		ms	
	DC (6mA sensor = pos. and neg. edge RCD type B = rising DC residual current)	Trip current $I_{\Delta N}=30\text{mA}$	$>3 \leq 6\text{mA}$ for 6mA sensor $\leq 60\text{mA}$ for RCD type B		Pos. edge	mA
					Neg. edge	mA
		Trip time	$<10\text{s}$ for 6mA $< 0.3\text{s}$ for type B		Pos. edge	S
			Neg. edge	S		

5 Functional tests

Test	Control panel (HMI)		Comments
	OK	NOK	
Charging process CCS	<input type="checkbox"/>	<input type="checkbox"/>	
Charging process CHAdeMO	<input type="checkbox"/>	<input type="checkbox"/>	
Charging process AC	<input type="checkbox"/>	<input type="checkbox"/>	
Closing mechanism	<input type="checkbox"/>	<input type="checkbox"/>	
Function test button RCD	<input type="checkbox"/>	<input type="checkbox"/>	Inspection every 6 months according to manufacturer
HRA tripping (hardware redundant shutdown)	<input type="checkbox"/>	<input type="checkbox"/>	Charging station in StandBy → Operate contactor AC charging point → RCD must trip
Parking position lighting	<input type="checkbox"/>	<input type="checkbox"/>	
RFID reader lighting	<input type="checkbox"/>	<input type="checkbox"/>	
Ambient lighting	<input type="checkbox"/>	<input type="checkbox"/>	
Insulation monitoring device Version: 1. Check with vehicle simulator with IMD test equipment, or 2. Check with separate resistance bridge	<input type="checkbox"/>	<input type="checkbox"/>	DC+ against PE
	<input type="checkbox"/>	<input type="checkbox"/>	DC- against PE

6 Additional work

Description	Completed	Not completed	Comments
Filter mat cleaning	<input type="checkbox"/>	<input type="checkbox"/>	
Filter mat replacement	<input type="checkbox"/>	<input type="checkbox"/>	

7 Result:

Test results	Yes	No
All tests were carried out	<input type="checkbox"/>	<input type="checkbox"/>
Defects present	<input type="checkbox"/>	<input type="checkbox"/>
Defect eliminated	<input type="checkbox"/>	<input type="checkbox"/>
Inspection tag attached	<input type="checkbox"/>	<input type="checkbox"/>

Comments:
Next test date on:
Place, date:
Tester: First and last name in block capitals
Signature:

13.4 Declarations of conformity

See also

 [i00022104_Vereinfachte DoC_rev02_EUSp \[▶ 107\]](#)

VEREINFACHTE EU-KONFORMITÄTSERKLÄRUNG (DE)

Hiermit erklärt Compleo Charging Solutions GmbH & Co. KG, dass der Funkanlagentyp **SOLO; DUO; DUO ims, Cito 500, eTower, eBox** der Richtlinie 2014/53/EU entspricht.

Der vollständige Text der EU-Konformitätserklärung ist unter der folgenden Internetadresse verfügbar: <https://www.compleo-charging.com/produkte/document-center>

SIMPLIFIED EU DECLARATION OF CONFORMITY (EN)

Hereby, Compleo Charging Solutions GmbH & Co. KG declares that the radio equipment type **SOLO; DUO; DUO ims, Cito 500, eTower, eBox** is in compliance with Directive 2014/53/EU.

The full text of the EU declaration of conformity is available at the following internet address: <https://www.compleo-charging.com/produkte/document-center>

DECLARATION UE DE CONFORMITE SIMPLIFIEE (FR)

Le soussigné, Compleo Charging Solutions GmbH & Co. KG, déclare que l'équipement radioélectrique du type **SOLO; DUO; DUO ims, Cito 500, eTower, eBox** est conforme à la directive 2014/53/UE.

Le texte complet de la déclaration UE de conformité est disponible à l'adresse internet suivante: <https://www.compleo-charging.com/produkte/document-center>

DICHIARAZIONE DI CONFORMITÀ UE SEMPLIFICATA (IT)

Il fabbricante, Compleo Charging Solutions GmbH & Co. KG, dichiara che il tipo di apparecchiatura radio **SOLO; DUO; DUO ims, Cito 500, eTower, eBox** è conforme alla direttiva 2014/53/UE.

Il testo completo della dichiarazione di conformità UE è disponibile al seguente indirizzo Internet: <https://www.compleo-charging.com/produkte/document-center>

VEREENVOUDIGDE EU-CONFORMITEITSVERKLARING (NL)

Hierbij verklaar ik, Compleo Charging Solutions GmbH & Co. KG, dat het type radioapparatuur **SOLO; DUO; DUO ims, Cito 500, eTower, eBox** conform is met Richtlijn 2014/53/EU.

De volledige tekst van de EU-conformiteitsverklaring kan worden geraadpleegd op het volgende internetadres: <https://www.compleo-charging.com/produkte/document-center>

FORENKLET EU-OVERENSSTEMMELSESERKLÆRING (DA)

Hermed erklærer Compleo Charging Solutions GmbH & Co. KG, at radioudstyrstypen **SOLO; DUO; DUO ims, Cito 500, eTower, eBox** er i overensstemmelse med direktiv 2014/53/EU.

EU-overensstemmelseserklæringens fulde tekst kan findes på følgende internetadresse: <https://www.compleo-charging.com/produkte/document-center>

YKSINKERTAISTETTU EU-VAATIMUSTENMUKAISUUSVAKUUTUS (FI)

Compleo Charging Solutions GmbH & Co. KG vakuuttaa, että radiolaitetyyppi **SOLO; DUO; DUO ims, Cito 500, eTower, eBox** on direktiivin 2014/53/EU mukainen.

EU-vaatimustenmukaisuusvakuutuksen täysimittainen teksti on saatavilla seuraavassa internetosoitteessa: <https://www.compleo-charging.com/produkte/document-center>

FÖRENKLAD EU-FÖRSÄKRAN OM ÖVERENSSTÄMMELSE (SV)

Härmed försäkras Compleo Charging Solutions GmbH & Co. KG att denna typ av radioutrustning **SOLO; DUO; DUO ims, Cito 500, eTower, eBox** överensstämmer med direktiv 2014/53/EU.

Den fullständiga texten till EU-försäkran om överensstämmelse finns på följande webbadress: <https://www.compleo-charging.com/produkte/document-center>

13.5 Memory and display module SAM



See also

 [BA SAM_Inter_Rev06_DE \[▶ 110\]](#)

Operating instruction

SAM International

SW2.0.2

Article Number: SAM inter





The power to move

Table of contents

1	About this manual.....	5
1.1	Conventions of presentation.....	5
1.2	Abbreviations	6
1.3	Locations and contact information.....	7
2	Safety	8
2.1	Warnings.....	8
2.1.1	Sectional warnings.....	8
2.2	Personnel qualification.....	9
2.3	Dangers and residual risks	10
2.4	Electrical voltage	10
3	Notes on the following chapters.....	11
4	SAM product description	12
4.1	Product information.....	12
4.2	Intended use.....	12
4.3	Type and rating plates	14
4.4	Overview of all displays (examples).....	15
4.4.1	Info screens (without interaction with the user).....	16
4.4.2	SAM displays for contract-based charging/roaming	17
4.4.3	Interactive screen displays with the user to invoke charging procedures.....	18
4.4.4	SAM displays for ad hoc charging (payment)	19
4.4.5	Possible information screens	20
4.4.6	Possible error screens	21
4.4.7	Lock screen	21
4.5	SAM system overview	22
4.6	Communication connections	23
4.7	Power supply	23
4.8	SAM system overview – Module	24
4.9	Time measurement of the charging service duration according to calibration law (stopwatch function).....	26
5	Charging process with SAM.....	30
5.1	Readiness	30
5.2	Authorisation.....	30
5.3	Two seconds until charging	31
5.4	Charging process.....	31
5.5	End of the charging process.....	32
6	Query previous charging processes with SAM	33
6.1	Query via backend (not secured under calibration law).....	33

6.2	On-site query (secured under calibration law)	33
7	Technical data for measuring capsule.....	37
8	Installation of the SAM	38
8.1	Connections	38
8.2	Connection of SAM and meter	38
9	Displaying the billing system	39
9.1	Billing with payment (with tariff).....	39
9.1.1	Start screen (idle mode)	39
9.1.2	Display after authorisation	39
9.1.3	Payment components data tuple.....	40
9.1.4	Displays for charging process.....	41
9.1.5	Charging process start sequence	42
9.1.6	Charging process end sequence	44
9.1.7	Retrieve historical charging data	45
9.2	Billing with roaming (without tariff).....	45
9.2.1	Start screen (idle mode)	45
9.2.2	Display after authorisation	46
9.2.3	Displays for charging process.....	46
9.2.4	RFID components data tuple.....	46
9.2.5	Charging process start sequence	47
9.2.6	Charging process end sequence	48
9.3	Retrieval of the customer receipt via the document server	49
9.4	Traceability of payment process/customer (for the CPO of the charging station)	52
10	Language selection.....	54

1 About this manual

This manual contains descriptions and important information for the safe and trouble-free use of the charging system.

The manual is part of the charging system and must be accessible at all times to all persons working on and with the charging system. The manual must be kept in a clearly legible condition.

The personnel must have carefully read and understood this manual before starting any work. The basic prerequisite for safe working is the observance of all specified safety and warning instructions as well as handling instructions in this manual.

In addition to the instructions in this manual, the local accident prevention regulations and the national industrial safety regulations apply.

Illustrations are for basic understanding and may differ from the actual design of the charging system.

Additional information on the product: <https://www.compleo-charging.com/produkte/document-center>.

1.1 Conventions of presentation

For easy and quick understanding, different information in this manual is presented or highlighted as follows:

- List without fixed order
- List (next item)
 - Subitem
 - Subitem
- 1. Handling instruction (step) 1
- 2. Handling instruction (step) 2
 - ⇒ Additional notes for the previous step

(1) Position number in figures and keys

(2) Consecutive position number

(3)...

Reference (example): See "chapter 6.5, page 27"







INFORMATION

Information contains application tips, but no hazard warnings.

1.2 Abbreviations

Abbreviation	Explanation
AC	Alternating Current
BM	Floor mounting on prefabricated base or load-bearing ground
CCS	Combined Charging System
CHA	Abbreviation for plug designation: CHAdeMO
CPO	Charge Point Operator
DC	Direct Current
eHZ	electronic domestic meter
EKA	Billing in compliance with calibration law
EMC	Electromagnetic Compatibility
fleet	Charging station with busbar system
HAK	Domestic junction box
IMD	Insulation Monitoring Device IEC 61557-8
IMS	Intelligent measuring system
CMS	Cable management system
MCB	Miniature Circuit Breaker
MessEG	Measuring and calibration law
MessEV	Measuring and calibration regulations
N/A	Not Available/ Applicable
OCPP	Open Charge Point Protocol
PT	Payment Terminal
RCD	Residual Current Device
RDC-DD	Residual Direct Current-Detecting Device
S/N	Serial number
SAM	Memory and display module
SPD	Surge Protective Devices
SVHC	Substances of Very High Concern
UV	Sub-distribution
WLL	Work Load Limit

1.3 Locations and contact information

 Compleo Charging Solutions GmbH & Co. KG Ezzestraße 8 44379 Dortmund, Germany	+49 231 53492370 info@compleo-cs.com compleo-charging.com
 Compleo Charging Solutions UK Ltd. The Lambourn, Wyndyke Furlong Abingdon, OX14 1UJ, United Kingdom	+44 1235 355189 hello.uk@compleo-cs.com compleocharging.co.uk
 Compleo Charging Solutions AG Switzerland Hardturmstrasse 161 8005 Zurich, Switzerland	info.ch@compleo-cs.com compleo-charging.ch
 Compleo Charging Solutions GmbH Speisinger Straße 25/12 1130 Vienna, Austria	infoAT@compleo-cs.com compleo.at
 Compleo CS Nordic AB Derbyvägen 4 212 35 Malmö, Sweden	+46 40 6850500 info.sweden@compleo-cs.com compleocs.se

2 Safety

To ensure operational safety of the charging equipment and to avoid serious injuries caused by flashovers or short circuits, the following information and safety instructions for operating the unit must be observed.

Repair work on the unit must only be carried out by authorised specialist personnel. The housing of the unit may only be opened by persons who have been properly instructed.

The following points always apply:

- Read and observe safety and warning instructions
- Read and follow instructions

2.1 Warnings

In this manual, warnings and notes are presented as follows.



DANGER

Indicates an imminent danger that will result in death or serious injury if not avoided. There is great danger to life.



WARNING

Indicates a potentially hazardous situation which could result in death or serious injury if not avoided.



CAUTION

Indicates a potentially hazardous situation which may result in minor or moderate injury if not avoided.



NOTICE

Indicates a potentially hazardous situation which may lead to material damage if not avoided.

2.1.1 Sectional warnings

Sectional warnings refer to entire chapters, a section or several paragraphs within this manual.

Sectional warnings are presented as follows (example warning):

**⚠ WARNING****Type and source of the danger**

Possible consequences if the danger is ignored.

- Measures to avoid the danger.

2.2 Personnel qualification

Qualified and trained electricians meet the following requirements:

- Knowledge of general and special safety and accident prevention regulations.
- Knowledge of the relevant electrotechnical regulations.
- Product-specific knowledge through appropriate training.
- Ability to identify hazards associated with electricity.

**⚠ DANGER****Danger due to electric current**

Touching live parts will result in electric shock with serious injury or death.

- Work on electrical components may only be carried out by a qualified electrician and in accordance with electrotechnical regulations.
- Ensure absence of voltage and take suitable protective measures.

2.3 Dangers and residual risks



NOTICE

Compleo charging systems as a whole do not contain SVHCs (Substances of Very High Concern) in a concentration of more than 0.1 % (w/w), related to the individual charging station. However, individual components may contain SVHCs in concentrations > 0.1 % (w/w).

- When the charging stations are used as intended, no SVHCs are released and there are no risks to humans or the environment.

2.4 Electrical voltage

Dangerous electrical voltages may be present inside the housing of the charging system after the housing has been opened. There is a danger to life if contact is made with live components. Serious injury or death is the result.

- Work on electrical equipment may only be carried out by a qualified electrician and in accordance with electrical engineering rules.
- Disconnect the charging system from the power supply.

3 Notes on the following chapters

Product assignment

These instructions are valid for the following product versions:

Hardware version:

- V1.0 (DE-17-M-PTB-0087 all revisions and DE-19-M-PTB-0300 initial document)
- V2.0 (DE-19-M-PTB-0030 revision 1 or higher)

Software version:

- V2.0.2 (DE-24-M-PTB-0011)

4 SAM product description

SAM is the memory and display module that permanently stores the start and final meter reading of the charging processes and displays them on request.

4.1 Product information

SAM, in combination with a verified meter, fulfils the possible requirements of the local calibration law when charging an electric vehicle at a charging station.

The unit offers advantages for several market participants:

User:

- Verified billing of kWh and charging time
- SAM is visible to the user at the charging point from the outside and enables a comparison of the meter values on site and on the bill
- Checking of the meter values by the user is possible without additional devices (e.g. computer, internet access, etc.)
- The displayed values are binding in case of dispute

Charging station operator:

- Significant reduction of complexity in the system compared to alternative solutions ("keep it simple")
- SAM is a cross-market solution: It is roaming-capable from the start and offers independence from CPO, MSP, backend
- No additional technical requirements for the CPO backend system and downstream data transfer (e.g. communication, storage,, etc.)
- OCPP 1.5 ff can be used unchanged, no transmission of signed meter values is required
- All data relevant to the bill is transferred to the backend via OCPP and is available to all market participants
- One-off costs for procurement - no running costs

4.2 Intended use

The SAM is used to collect, store, display and verify meter reading and customer identification data for charging points in charging stations for electric vehicles. One SAM is used per charging point. The SAM is a measuring capsule and consists of the display & storage module and an electronic energy meter. It displays the determined data and stores it permanently in the device itself.

The SAM is designed for mounting on a wall or for a charging station and is to be installed weather protected. The intended use of the product also includes compliance with all the information in these instructions. Any use beyond the intended use or any other use is considered misuse.

The specified ambient conditions for this product must also be observed in all cases (see also chapter 7 *Technical data for measuring capsule, page 37*). The SAM has been designed, manufactured and tested in compliance with the relevant safety standards.

If the safety instructions are observed and the product is used as intended, there is normally no risk of damage to property or to the health of persons.

Failure to observe the instructions contained in this manual may create sources of danger or render safety devices ineffective. Furthermore, the local safety and accident prevention regulations must be observed for the respective application.

4.3 Type and rating plates

The SAM type plate and meter rating plate are listed below. Typically, the SAM type plate is visible from the outside (view of the charging station) and the meter rating plate is not.



- Upper field: Company logo
- Left field: Product name
- Right field: Manufacturer's address
- Lower field:
 - Metrology marking
 - CE marking
 - Type designation SAM incl. serial number/ type key (can be used for HW

identification)

- QR code (contains the type designation and serial number)
- Accuracy classification

Type plate of the SAM

Display frame: Labelled with

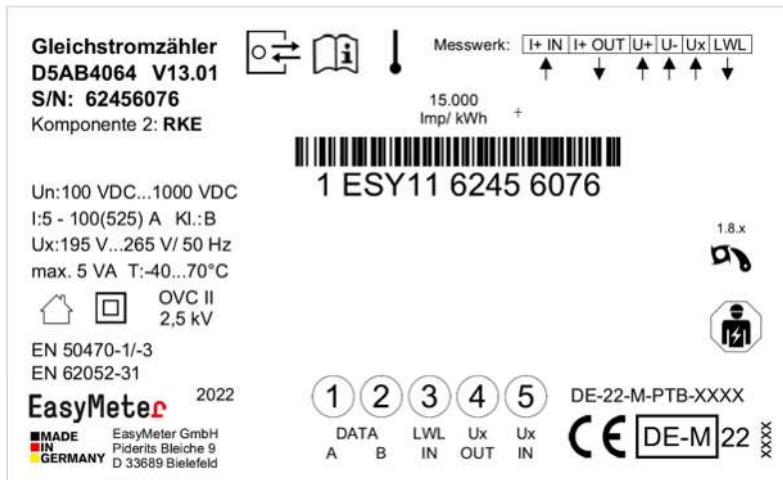

Rating plate of the meter (sample image)

4.4 Overview of all displays (examples)

Explanation of the display positions:

Text displays during boot screen after switching on and restarting the SAM	
SAM S/N	SAM serial number
Crypto lib.	Identification feature of software connection
SAM SW	SAM firmware version
SAM checksum	SAM firmware checksum
Manufacture date	Day of manufacture (day of programming)
Charge possible	Number of charging processes that are still possible and can be saved.
Meter S/N	Meter serial number
Meter type	Type of meter
Meter SW	Meter firmware version
Meter checksum	Meter firmware checksum

Text displays during operation of the charging column.	
Date & time	The current date and time are permanently displayed in the first line. The date is displayed in the format dd.mm.yyyy, the time is displayed in the format hh:mm:ss.
Initial reading	The initial value represents the meter reading at the beginning of a specific charging process. It is displayed during a charging process and also when a completed charging process is displayed. The display is in kilowatt hours.
Final reading	The final value is displayed after finishing and when retrieving a finished charging process. The display is in kilowatt hours.
Consumption	Difference between the initial value and the actual value. After completion of the charging process, it is the difference between the start and final value (power extracted). The display is in kilowatt hours.
Start	At this point, the start time of the charging process is recorded. Both the date and the time are relevant here.
End	At this point, the end time of the charging process is recorded. Both the date and the time are relevant here.
Duration	Time from the start of the charging process to the current time. When charging is complete, the total time from start to finish is displayed. The duration is displayed in the format hh:mm:ss ss or, from a duration of 1 day, in the format dd:hh:mm.
ID	The user ID used for authorisation is shown here. During the charging process, this cannot be recognised except for a few leading digits.
Type 2	– Delivery point has a type 2 plug.
CCS	– Delivery point has a CCS plug.
CHA	– Delivery point has a CHAdeMO plug.

4.4.1 Info screens (without interaction with the user)

The boot screens (1) and (2) change on a rolling basis.

Compleo CS - SAM		Compleo CS - Meter	
SAM S/N:	124123452	Meter S/N:	1 ESY0b 61132767
Crypto Lib.	m040000B1	Meter type:	D5A
SAM SW:	V2.0.0	Meter SW:	13.01
SAM checksum:	0xAAAA	Meter checksum:	76E7
Manufacture Date:	10.11.2023		
Charging possible:	65423		
Boot screen (1)		Boot screen (2)	
09.01.2024	14:35:29		
CCS:	DE*DC*TYP2		
Ready for operation			
Ready for operation (idle state)			

4.4.2 SAM displays for contract-based charging/roaming

27.06.2022 14:35:29 ID: 99ADXXXXXXXXXXXXXXXXXX TYP2: DE*DC*TYP2 Ready for operation	27.06.2022 14:35:29 ID: 99ADXXXXXXXXXXXXXXXXXX EVSE-ID: DE*DC*TYP2 Ready for operation
Display of the ID after an authorisation	2 second progress bar (from left to right) until the timing starts.
20.06.2022 13:15:20 Consumption: 0,00 kWh Start: 20.06.2022 13:14:58 Duration: 00:00:22 ID: 99ADXXXXXXXXXXXXXXXXXX EVSE-ID: DE*EBG*DC*TYP2 >>> Charging active <<<	20.06.2022 13:15:20 Consumption: 0,00 kWh Start: 20.06.2022 13:14:58 Duration: 00:00:22 ID: 99ADXXXXXXXXXXXXXXXXXX EVSE-ID: DE*EBG*DC*TYP2 >>> Charging active <<<
Current measured values. The number of arrow symbols represent the number of loaded phases.	Display of duration with tenths of seconds, only in the first minutes after the start.
27.06.2022 14:35:29 Start mtr reading: 20,92 kWh Final mtr readg: 20,93 kWh Consumption: 0,01 kWh Start: 27.06.2022 14:34:12 End: 27.06.2022 14:35:23 Duration: 00:01:11 ID: 99ADXXXXXXXXXXXXXXXXXX EVSE-ID: DE*DC*TYP2 (1)	
Summary at the end of the charging process.	

4.4.3 Interactive screen displays with the user to invoke charging procedures

27.06.2022 14:35:29	17.06.2022 14:35:29
Start meter reading entry	Final meter reading entry
Start mtr reading: 000020,90 kWh	Start mtr reading: 000020,90 kWh
	Final mtr readg: 000000,00 kWh
Next	Check
Cancel	Cancel
After entering the start value, press "Next" to enter the final value. (Called up after touching one of the two buttons).	After entering the final value, press "Check".
27.06.2022 14:35:29	27.06.2022 14:35:29
Start mtr reading: 20,92 kWh	Start mtr reading: 20,92 kWh
Final mtr readg: 20,93 kWh	Final mtr readg: 20,93 kWh
Consumption: 0,01 kWh	Consumption: 0,01 kWh
Start: 27.06.2022 14:34:12	Start: 27.06.2022 14:34:12
End: 27.06.2022 14:35:23	End: 27.06.2022 14:35:23
Duration: 00:01:11	Duration: 00:01:11
ID: PY2291F221DO18FEF99	ID: PY2291F221DO18FEF99
EVSE-ID: DE*DC*TYP2 (1)	EVSE-ID: DE*DC*TYP2 (1)
Screen output for a found entry.	If there are several data sets (possible with a charge of ≤ 0 Wh), scrolling is possible.

4.4.4 SAM displays for ad hoc charging (payment)

27.06.2022 14:35:29 ID: PY2291F221D018FEF99 TYP2: DE*DC*TYP2 Energy price/kWh: 0,32 EUR Usage fee/min: 0,30 EUR Fee charged from: 5 min Ready for operation	27.06.2022 14:35:29 ID: PY2291F221D018FEF99 TYP2: DE*DC*TYP2 Energy price/kWh: 0,32 EUR Usage fee/min: 0,30 EUR Fee charged from: 5 min Ready for operation
Display of the ID after a successful authorisation.	2 second progress bar (from left to right) until the timing starts.
20.06.2022 13:15:20 Consumption: 0,00 kWh Start: 20.06.2022 13:14:58 Duration: 00:00:22 ID: PY22XXXXXXXXXXXXXXXXXX TYP2: DE*EBG*DC*TYP2 >>> Charging active <<<	20.06.2022 13:28:47 Consumption: 0,00 kWh Start: 20.06.2022 13:28:47 Energy price/kWh: 0,32 EUR ID: PY22XXXXXXXXXXXXXXXXXX TYP2: DE*EBG*DC*TYP2 >>> Charging active <<<
Current measured values screen 1. Displays for charging process The number of arrow symbols represent the number of loaded phases.	Current measured values screen 2. Energy price/kWh displays The number of arrow symbols represent the number of loaded phases.

20.06.2022	13:26:08	20.06.2022	13:20:12
Consumption:	0,00 kWh	Consumption:	0,00 kWh
Start:	20.06.2022 13:25:46	Start:	20.06.2022 13:19:50
Fee charged from:	5 min	Usage fee/min:	0,30 EUR
ID:	PY22XXXXXXXXXXXXXXXXXX	ID:	PY22XXXXXXXXXXXXXXXXXX
TYP2:	DE*EBG*DC*TYP2	TYP2:	DE*EBG*DC*TYP2
>>>	Charging active <<<	>>>	Charging active <<<
Current measured values screen 3. Usage fee due from		Current measured values screen 4. Usage fee/minute	
The number of arrow symbols represent the number of loaded phases.		The number of arrow symbols represent the number of loaded phases.	
27.06.2022	14:35:29		
Start mtr reading:	20,92 kWh		
Final mtr readg:	20,93 kWh		
Consumption:	0,01 kWh		
Start:	27.06.2022 14:34:12		
End:	27.06.2022 14:35:23		
Duration:	00:01:11		
ID:	PY2291F221DO18FEF99		
TYP2:	DE*DC*TYP2		
	(1)		

4.4.5 Possible information screens

27.06.2022	14:35:29	27.06.2022	14:35:29
Start mtr reading:	20,92 kWh	Consumption:	0,00 kWh
Final mtr readg:	20,93 kWh	Start:	27.06.2022 14:35:07
Consumption:	0,01 kWh	Duration:	invalid
Start:	27.06.2022 14:34:12	ID:	PY22XXXXXXXXXXXXXXXXXX
End:	27.06.2022 14:35:23	TYP2:	DE*DC*TYP2
Duration:	invalid	>	Charging active <
ID:	PY2291F221DO18FEF99		
TYP2:	DE*DC*TYP2		
	(1)		
"Invalid" notice in the charging process summary if there was a communication problem. The data set is not billable according to time!		Notice if there was a communication problem during the charging process. The data set is not billable according to time!	

4.4.6 Possible error screens

27.06.2022	14:35:29	27.06.2022	14:35:29
Limited operation Billing not possible based on the measured values Data query possible		Out of service Billing not possible based on the measured values Data query not possible	
Error message: there is a communication or memory problem.		Error message: there is an internal fault in the SAM.	
27.06.2022	14:35:29	27.06.2022	14:35:29
Entry not found Renewed Cancel		Billing not possible based on the measured values	
Error message: no entry was found. Billing is only possible with a data set that complies with calibration law!		Error message: the data set found is inconsistent. The data set does not comply with calibration law and is therefore cannot be billed!	

4.4.7 Lock screen

27.06.2022	14:35:29
Data verification blocked Next possibility to check in - 15046 seconds OK	
Lock screen after 5 incorrect queries/entries	

4.5 SAM system overview

The SAM forms a unit with the associated meter, which is used to record and store measured values.

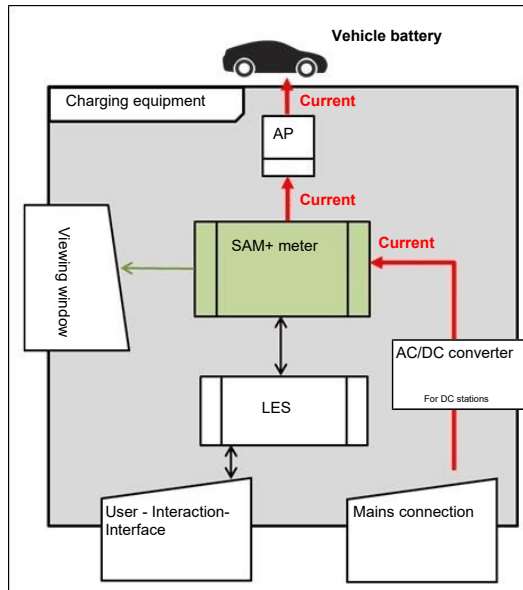

The adjacent image shows the functional arrangement of the SAM (green) in a charging station.

For DC charging stations, an AC/DC converter is also used between the mains connection and the measuring capsule (SAM + meter).

4.6 Communication connections

The SAM is equipped with the following non-reactive communication interfaces:

- IR interface: Point-to-point connection to the electricity meter
- 20 mA interface: Point-to-point connection to the charging system control unit (LES)
- HMI interface (2 buttons and display) for interaction with the user

Connection to the electricity meter

The memory and display module is connected to the electricity meter via a secure connection in accordance with calibration law. This connection is established via an optical interface.

Depending on the operating state, the values are

- automatically sent out cyclically by the meter or
- actively queried by the SAM.

Connection to the LES

The memory and display module is connected to the LES via a 20 mA interface (current loop). The SAM sends the received meter values unchanged to the control unit. In addition, the result of a start and final meter reading query is transmitted.

The control unit sends the following information to the SAM:

1. Start of the charging process for the corresponding delivery point
2. End of the corresponding charging process
3. ID for the associated start and final meter reading
4. Date and time
5. Voltage
6. Correction factor (resistance to system power loss)

See chapter 9.1.3 *Payment components data tuple*, page 40.

4.7 Power supply

In the AC system, the AC meter is connected to the mains connection on the input side via electrical protective measures such as charging station fuses and main switches. On the output side, the delivery point (AP) is supplied with power via an AC contactor. The user can charge his vehicle via the delivery point (socket or charging cable).

For the DC system, the DC meter is connected on the input side via an AC/DC converter with integrated protective devices. On the output side, the delivery point (AP) is supplied with power via DC contactors.

4.8 SAM system overview – Module

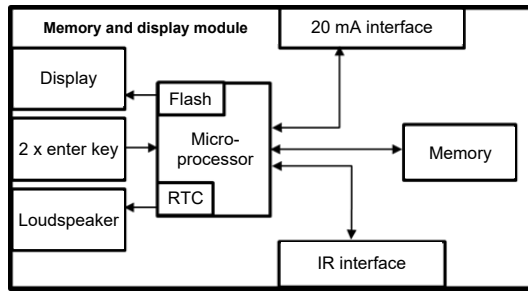

The adjacent image shows the internal relevant components of the SAM.

The memory and display module is equipped with the following components:

Micro-controller

The micro-controller has an integrated flash memory and an RTC.

- The flash memory is used for the firmware (without update function).
- The RTC is used for the calendar, time and stopwatch function.

Additional flash memory

The additional and non-volatile long-term memory is used for storing charging processes and can be read out by the control unit.

The following data is collected and stored as a tuple:

1. Identifier(1 byte) identifier byte
2. StartTime (4 byte): Date and time at the start of the loading process
3. StartTimeOffset (2 byte) UTC offset at start
4. EnergyStart (4 byte): Meter reading at the start of the charging process [kWh]
5. Authentication ID (21 byte): ID
6. SLIN (1 byte): Security level of the ID
7. ParameterRef ID (2 byte) Reference to parameter set
8. PricePerKWh (2 byte) Price per charged kWh in cents
9. PricePerMinute (2 byte) Price per charged minute in cents
10. PriceMinDuration (2 byte) Duration of use in minutes from which the price per minute applies
11. Reserved (7 byte): Reserved area
12. CRC_Begin (2 byte): CRC over all written values at the start time
13. EndTime (4 byte): Date and time at the end of the loading process
14. EndTimeOffset (2 byte) UTC offset at stop
15. EnergyStop (4 byte): Meter reading at the end of the charging process [kWh]
16. ValidityStatus (2 byte): Bit0: No communication from the meter with MeasureStop
 - Bit1: Measuring duration not valid
 - Bit2: CRC error in the data set
17. CRC_Complete (2 byte): CRC over all written values

IR interface (optical)

The IR interface is used for communication with the MID electricity meter.

20 mA current interface

The 20 mA current interface is used for communication with the control unit.

Display

The display is used to show values relevant to the bill and to check the input of the bill data.

Input keys

The two capacitive input keys can be used for function selection and meter reading input by the user.

Loudspeaker

The loudspeaker is used for acoustic feedback, e.g. when keys are touched.

12 V supply connection

The SAM is supplied with 12 V operating voltage via the connection

4.9 Time measurement of the charging service duration according to calibration law (stopwatch function)

The SAM has an internal quartz-controlled real time clock (RTC). This is used for time measurement (for the charging time or standing time).

The charging service time is the time between the moment the charging equipment detects the connection of a vehicle and the moment the charging equipment detects the disconnection of the vehicle from the charging equipment.

The start condition for recording the charging service duration is successful authorisation at the charging station and the connection to the vehicle (plug inserted on both sides).

The stop condition for recording the charging service duration:

1. For a charging line connected at the charging point of the charging equipment, the disconnection of the connection to the vehicle at the charging equipment (the trigger is the disconnection of the control pilot signal of the pilot circuit according to EN 61851-1).
2. For a socket at the charging point of the charging equipment, the disconnection of the external charging cable at the charging station.

Internally, the time is measured with a resolution of one millisecond. The time is shown to the second on the display (for clarity), with the milliseconds truncated. This means that the seconds display does not show rounded values. The following figure illustrates this.

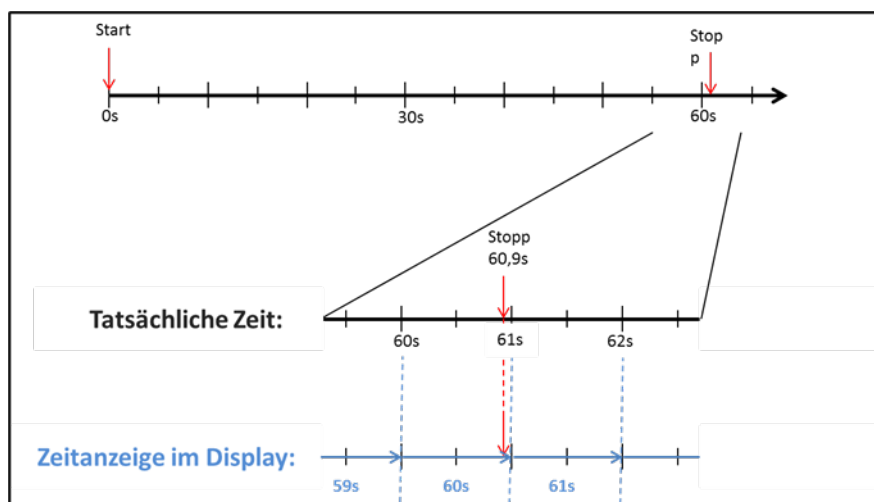

The options for checking this time measurement according to calibration law are described below.

Checking the time measurement by means of the display

In the display, a start bar accurate to the second is also shown, which begins a 2 second countdown (bar progresses from left to right) after the charging column is connected to the vehicle.

The time starts to be measured after the countdown. The measurement stops when the vehicle is disconnected from the charging station.



INFORMATION

The stopwatch continues to run after charging has stopped.

If the vehicle has its own charging cable, it is not sufficient to simply unplug the vehicle. The time measurement only stops when the plug is pulled out of the charging station.

To check the stopwatch yourself, the start time can be recognised via the start bar and the accuracy of the stopwatch function can be checked via a stopwatch. The verification time should be at least 10 minutes in order to demonstrate sufficient accuracy. According to the standard, a deviation of 1% is permissible.

Checking the time measurement by means of the data interface

The time measurement accurate to a millisecond can be read out from the SAM via the available 20 mA interface using the SML protocol.

Checking the time measurement in the manufacturing process

In each SAM, a connection pin is available which signals the start and stop time by means of a signal change (flank-controlled). With this signal in combination with the digital time measurement value (via the 20 mA interface), all SAMs are checked in the manufacturing process for the functionality and accuracy of the internal RTC.

The following diagram illustrates the check procedure.

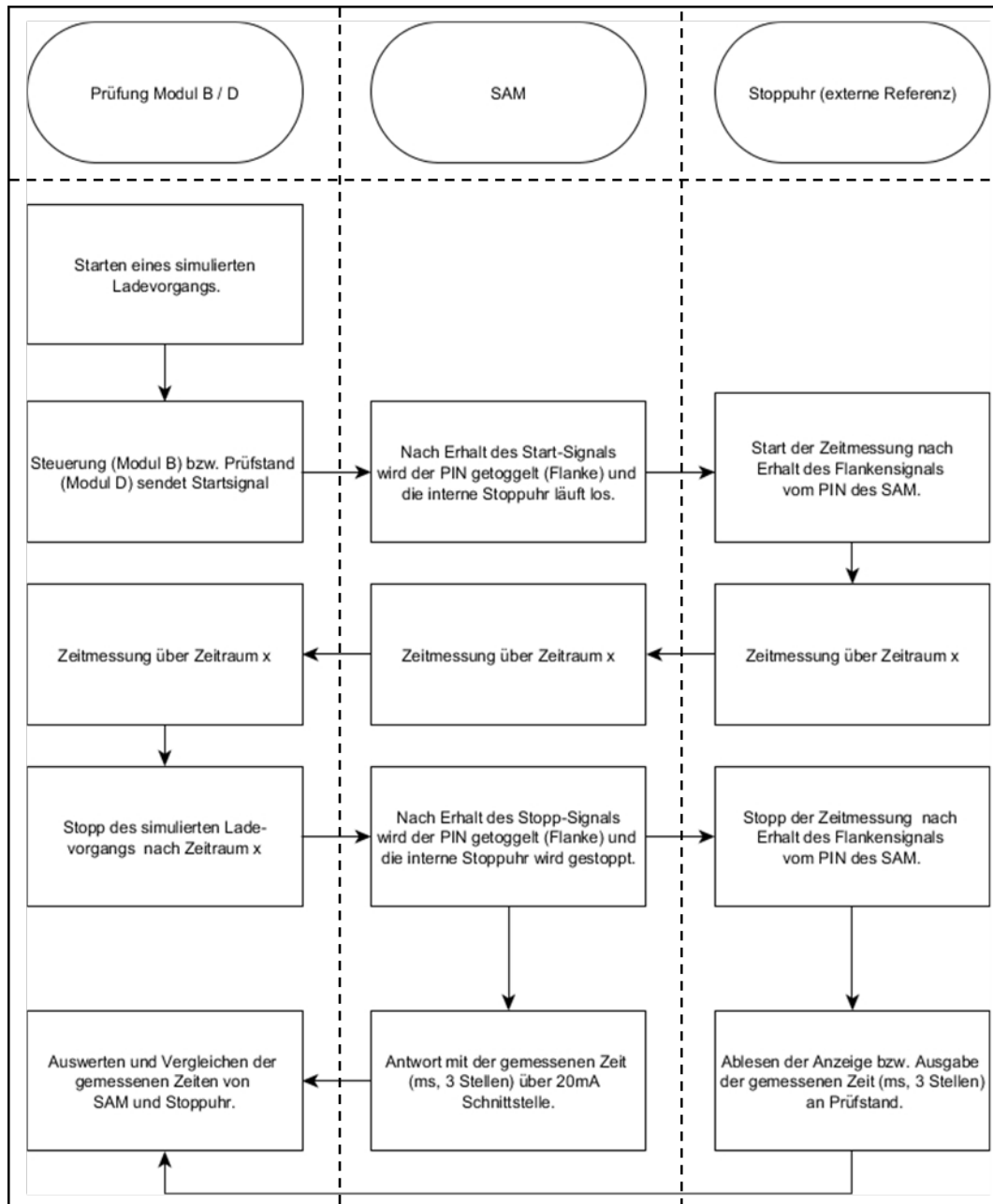

System overview of electricity meter

Depending on the version and application, the SAM is equipped with various AC and DC meters. These meters are approved meters according to calibration law and are used to measure the amount of energy supplied at the delivery points.

For detailed information, see chapter.

5 Charging process with SAM

This chapter explains in more detail the displays that are shown in the SAM during a charging process.

Charging processes that are carried out via authorization with a payment card are described in chapter 9.1 *Billing with payment (with tariff)*, page 39.

The charging process is described in the operating manual of the respective charging station.



INFORMATION

The variable data of the display representations are exemplary and deviate from the actual data during a charging process.



INFORMATION

If the display time deviates by >75 min. from the real time, it is recommended not to use the charging station.



INFORMATION

A measured value with a time duration < 60s must not be used for billing purposes!

5.1 Readiness

27.06.2022	14:35:29
TYP2:	DE*DC*TYP2
Ready for operation	

After the boot process, the SAM is ready for operation. The current date and time are displayed. If the display illumination is deactivated due to prolonged inactivity or restart, it can be activated by pressing one of the two keys.

5.2 Authorisation

27.06.2022	14:35:29
ID:	PY2291F221D018FEF99
TYP2:	DE*DC*TYP2
Ready for operation	

As soon as a user logs into the charging station and receives the corresponding authorisation to charge, the display changes and shows the corresponding ID for the upcoming charging process.

5.3 Two seconds until charging

27.06.2022	14:35:29
ID:	PY2291F221D018FEF99
EVSE-ID:	DE*DC*TYP2
	
Betriebsbereit	

As soon as a vehicle and the charging column are connected and the authorisation was successful, a black two-second progress bar (from left to right) is shown in the display.

5.4 Charging process

27.06.2022	14:35:29
Consumption:	0,00 kWh
Start:	27.06.2022 14:35:07
Duration:	00:00:22
ID:	PY22XXXXXXXXXXXXXXXXXX
TYP2:	DE*DC*TYP2
>>>	Charging active <<<

After this time has elapsed, the display changes to the next representation and the time measurement begins. During the entire charging process, the current information is shown on the display as in the following illustration.

In the last line, in addition to the information text "Charging active", the large and small characters (arrow symbols) are displayed. The number of characters

indicates, here three on each side, that all three phases in the charging line supply energy. If only two or only one character is displayed on each side, then correspondingly fewer phases provide energy. This depends on the onboard charger installed in the vehicle. Information about the installed onboard charger can be obtained from the car dealer or from the associated instructions for the vehicle.

If no characters are displayed, then the vehicle's battery probably cannot be charged any further.



INFORMATION

A few seconds after the start of the charging process, the personal ID is substituted by crosses except for a few leading digits for data protection reasons.

5.5 End of the charging process

27.06.2022	14:35:29
Start mtr reading:	20,92 kWh
Final mtr readg:	20,93 kWh
Consumption:	0,01 kWh
Start:	27.06.2022 14:34:12
End:	27.06.2022 14:35:23
Duration:	00:01:11
ID:	PY22911F221D018FEF99
TYP2:	DE*DC*TYP2
	(1)

After the charging process is completed (after disconnection from the vehicle on the charging station side), the information is shown on the display for checking purposes. The display can be extended by a further 20 seconds by pressing the right key and it closes automatically after this period has elapsed.



INFORMATION

In order for the end user to be able to exercise the option of a billing check, there should be a visible indication for the customer that the he should take a photo of the summary for this purpose (after the charging process!).

6 Query previous charging processes with SAM

6.1 Query via backend (not secured under calibration law)

Using OCPP, individual or all stored data sets can be retrieved from the backend via the charging equipment control unit.

6.2 On-site query (secured under calibration law)

Within the scope of saving all charging processes, the same can be called up after entering the start and final values of the meter readings of a specific charging process.



INFORMATION

You always have the right to query your historical charging processes at the respective charging point! However, please note that charging stations are subject to maintenance and repair intervals. In these cases, it is possible that the charging station is not accessible, has been taken out of service or the memory module has been replaced and you will not be able to access your data.

You should therefore check with the operator before driving to a charging point that involves a lot of effort (e.g. long driving time). The operator will provide you with access to your data or give you an option.

The following steps can be carried out using the two keys on the SAM. The left key is always used to advance the cursor to the next selection option and the right key to select an option or increase the selected digit. The currently selected position appears on a dark background.

The options at the bottom of the field cannot be selected directly by pressing the keys below, but are selected one after the other with the left key according to the individual digits. After selecting the last available option, the last digit is selected again so that corrections can be made without aborting.

27.06.2022	14:35:29
Start meter reading entry	
Start mtr reading:	000000,00 kWh
Next	
Cancel	

Entering the start value

The start value of the charging process to be queried is to be entered as previously described. Then select the "Next" option and confirm.

27.06.2022	14:35:29
Final meter reading entry	
Start mtr reading:	000020,90 kWh
Final mtr readg:	000000,00 kWh
Check	
Cancel	

Entering the final value

The final value of the same charging process is entered in the same way. Selecting the "Check" option outputs the desired information.

27.06.2022	14:35:29
Start mtr reading:	20,92 kWh
Final mtr readg:	20,93 kWh
Consumption:	0,01 kWh
Start:	27.06.2022 14:34:12
End:	27.06.2022 14:35:23
Duration:	00:01:11
ID:	PY2291F221D018FEF99
TYP2:	DE*DC*TYP2
	(1)

Display of the stored data

If the actual values are entered correctly, the information will be as shown in the adjacent illustration. The display can be closed with the right key, but it also closes itself after an appropriate time window.

If there are several data sets (possible with a charges $\leq 0\text{Wh}$), scrolling is possible.

27.06.2022	14:35:29
Consumption:	0,00 kWh
Start:	27.06.2022 14:35:07
Duration:	invalid
ID:	PY22XXXXXXXXXXXXXXXXXX
TYP2:	DE*DC*TYP2
>	Charging active
<	

Information screens

Charging equipment, including the measuring capsule according to calibration law, is a complex system that is subject to stringent legal requirements.

In certain situations, information screens are displayed if technical problems occur during a charging process.

The adjacent information screens are displayed if either a power failure or the communication between the SAM and the control unit was interrupted during a charging process. Then the word "Invalid" is shown in the display under Duration.

Likewise, in the summary (at the end of the charging process), the word "Invalid" is shown in the display under Duration.

27.06.2022	14:35:29
Start mtr reading:	20,92 kWh
Final mtr readg:	20,93 kWh
Consumption:	0,01 kWh
Start:	27.06.2022 14:34:12
End:	27.06.2022 14:35:23
Duration:	invalid
ID:	PY2291F221D018FEF99
TYP2:	DE*DC*TYP2
	(1)



INFORMATION

Billing by time not possible!

If the duration is declared invalid, then the time measurement is not according to calibration law and therefore cannot be billed.

27.06.2022 14:35:29

Limited operation

Billing not possible based on the measured values

Data query possible

Error screens

Permanent error states in charging equipment cannot be excluded either. The following error screens are possible and are explained here.

"Limited operation" occurs when

1. energy measurements are no longer possible. (e.g. meter is not working

correctly)

⇒ Consequence: The charging point goes to "Out of service".

2. the data memory is full or no further charging processes can be saved.

⇒ Consequence: Charging processes are still enabled, but these may not be billed.

3. the RCD trips during a charging process.

⇒ Consequence: The charging point goes to "Out of service" and the charging process is terminated.

27.06.2022 14:35:29

Out of service

Billing not possible based on the measured values

Data query not possible

The SAM is "Out of service" when

4. key operation no longer works.

⇒ Consequence: Charging processes are still enabled, but they may not be billed.

5. the firmware of the SAM is inconsistent.

⇒ Consequence: The charging point goes to "Out of service".



INFORMATION

Bills may only be made with existing data sets according to calibration law.

27.06.2022 14:35:29

Entry not found

Renewed

Cancel

An entry in the data memory cannot be found if

6. the two start and end meter readings entered are not found in the data set (tuple). The operator has either entered incorrect values or has entered the data at an incorrect charging point (SAM).



INFORMATION

Only charging processes at the respective charging point are saved. There is no data exchange between the charging points.

27.06.2022 14:35:29



Lock screen

The adjacent picture shows the lock screen. This screen appears if five incorrect entries took place while entering readings to retrieve historical data. This function is intended to prevent misuse.

7 Technical data for measuring capsule

Unless otherwise stated, the technical specifications are the same for all unit types.

Ambient conditions

Specification	Value	Unit
Approved installation site	Interiors or at least IP34 protected area	
Temperature range	-25 to +70	°C
Humidity	≤ 95	%
Mechanical/EMC requirement class:	M1/E2	

Technical data of the SAM, nominal operating conditions

Specification	Value	Unit
Supply voltage	12	V
Power consumption	≤ 0.7	W
Protection class (housing)	IP 54	
Limit current I_{max}	≤ 60	mA
Electromagnetic environmental conditions	Testing was carried out according to DIN EN 50470	

8 Installation of the SAM

8.1 Connections



NOTICE

Connections, see block diagrams in chapter.

8.2 Connection of SAM and meter

Please observe the following safety instructions before connecting the unit.

Specifications for the electrical connection

- The supply line must be hard-wired into the existing installation and comply with the applicable national legal regulations.
- The rated current I_N must be selected to match the back-up fuse and the circuit breaker.
- When designing the supply line, take into account the increased ambient temperatures inside a charging column and possible reduction factors. Increased line cross-sections may be necessary to adapt the temperature resistance of the supply line.



INFORMATION

The SAM as well as the meter must be connected when the system is de-energised.

The mounting position does not affect the functionality.

Tightening torque of the clamping screws 3 Nm (M6).

The recommended conductor cross-section for connecting the meter is: Q3MB1020 ($I_{max} = 60A$) = 16mm².

Damage to property may occur due to incorrect connection!



WARNING

When connecting the meter, there is a risk of fire if the connection cables have too high an internal resistance!

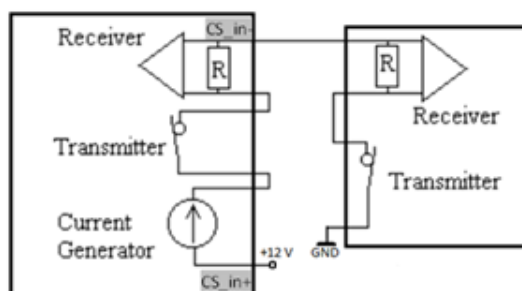

Connecting the SAM to the controller

The pin assignment of the SAM is listed in the chapter *8.1 Connections*, page 38.

The pin assignment of the control unit can be found in the corresponding operating manual for the control unit.

9 Displaying the billing system



INFORMATION

The functions described below do not apply to all product variants.

9.1 Billing with payment (with tariff)

Payment by debit card, credit card, Google PAY, Apple PAY, etc.

9.1.1 Start screen (idle mode)

09.01.2024	14:35:29
CCS:	DE*DC*TYP2
Ready for operation	

Displays:

- Charging connection type

9.1.2 Display after authorisation

27.06.2022	14:35:29
ID:	PY2291F221D018FEF99
TYP2:	DE*DC*TYP2
Energy price/kWh:	0,32 EUR
Usage fee/min:	0,30 EUR
Fee charged from:	5 min
Ready for operation	

Displays:

- Payment ID (after authorisation)
- Charging connection type
- Energy price according to tariff
- Usage fee
- Due date of the usage fee

9.1.3 Payment components data tuple

- Meter reading at the start of the measurement procedure
- Meter reading at the end of the measurement procedure
- Identification number of the contractual partner (payment ID)
- Duration of the measurement procedure
- Integrity/validity of the data set
- Transaction number from SAM
- Time stamp at start
- Time stamp at stop
- Security level of the identification number (SLIN)
- Price per kWh
- Time tariff per minute
- Start of the time tariff



INFORMATION

The payment ID is the user identification for charging processes via payment card.

The Payment ID is structured as follows: "Prefix + Terminal ID + Trace ID + Year"

Example: PY921673492466712022

9.1.4 Displays for charging process

The display sequence (1-2-3-4) scrolls at 5-second intervals.

20.06.2022	13:15:20
Consumption:	0,00 kWh
Start:	20.06.2022 13:14:58
Duration:	00:00:22
ID:	PY22XXXXXXXXXXXXXXXXXX
TYP2:	DE*EBG*DC*TYP2
>>>	Charging active <<<

(1)

20.06.2022	13:28:47
Consumption:	0,00 kWh
Start:	20.06.2022 13:28:25
Energiepreis/kWh:	0,32 EUR
ID:	PY22XXXXXXXXXXXXXXXXXX
TYP2:	DE*EBG*DC*TYP2
>>>	Charging active <<<

(2)

20.06.2022	13:26:08
Consumption:	0,00 kWh
Start:	20.06.2022 13:25:46
Fee charged from:	5 min
ID:	PY22XXXXXXXXXXXXXXXXXX
TYP2:	DE*EBG*DC*TYP2
>>>	Charging active <<<

(3)

20.06.2022	13:20:12
Consumption:	0,00 kWh
Start:	20.06.2022 13:19:50
Usage fee/min:	0.30 EUR
ID:	PY22XXXXXXXXXXXXXXXXXX
TYP2:	DE*EBG*DC*TYP2
>>>	Charging active <<<

(4)

9.1.5 Charging process start sequence



SAM display shows Ready for operation.



1. Start the charging process by presenting a payment card.
 - ⇒ The info display of the charging system shows information on pricing and contract modalities on a rolling basis.
2. Enter PIN if prompted.



3. Wait until the authorisation has been completed.
 - ⇒ Info display shows successful authorisation.
 - ⇒ SAM display shows price information.





4. Connect vehicle to the charging system.

⇒ SAM display shows information on charging price and duration on a rolling basis.

9.1.6 Charging process end sequence



1. Stop the charging process by presenting the same payment card.

⇒ The SAM display shows the meter and data readings, the consumption of the charge carried out, as well as the tariff, usage fee and time in blocks at 5-second intervals on a rolling basis.

9.1.7 Retrieve historical charging data

The display sequence (block 1 – block 2) scrolls at 5-second intervals.

27.06.2022	14:35:29	Display block 1:
Start mtr reading:	20,92 kWh	
Final mtr readg:	20,93 kWh	- Start of charging
Consumption:	0,01 kWh	- End of charging
Start:	27.06.2022 14:34:12	- Duration of charging
End:	27.06.2022 14:35:23	
Duration:	00:01:11	
ID:	PY2291F221D018FEF99	
TYP2:	DE*DC*TYP2	
	(1)	

20.06.2022	13:28:47 PM	Display block 2:
Start mtr reading:	20,92 kWh	
Final mtr readg:	20,93 kWh	- Energy price according to tariff
Consumption:	0,01 kWh	- Usage fee
Energy price/kWh:	2,34 EUR	- Due date of the usage fee
Usage fee/min:	9,87 EUR	
Fee charged from:	12 min	
ID:	PY2291F221D018FEF99	
TYP2:	DE*EBG*DC*TYP2	
	(1)	

The procedure for retrieving the data is described in chapter 6 *Query previous charging processes with SAM*, page 33.

9.2 Billing with roaming (without tariff)

Contract-based charging with RFID cards, fleet cards, customer RFID cards, etc.

9.2.1 Start screen (idle mode)

09.01.2024	14:35:29	Displays:
CCS:	DE*DC*TYP2	
		- Charging connection type
Ready for operation		

9.2.2 Display after authorisation

27.06.2022	14:35:29
ID:	99ADXXXXXXXXXXXXXXXXXX
TYP2:	DE*DC*TYP2
Ready for operation	

Roaming displays:

- Charging connection type
- User ID (after authorisation)

9.2.3 Displays for charging process

20.06.2022	13:15:20
Consumption:	0,00 kWh
Start:	20.06.2022 13:14:58
Duration:	00:00:22
ID:	99ADXXXXXXXXXXXXXXXXXX
EVSE-ID:	DE*EBG*DC*TYP2
>>>	Charging active <<<

The displays for charging processes via roaming remain unchanged.

The procedure for retrieving the data is described in chapter 6 *Query previous charging processes with SAM*, page 33.

9.2.4 RFID components data tuple

- Meter reading at the start of the measurement procedure
- Meter reading at the end of the measurement procedure
- Identification number of the contractual partner (UID of the RFID card)
- Duration of the measurement procedure
- Integrity/validity of the data set
- Transaction number from SAM
- Time stamp at start
- Time stamp at stop
- Security level of the identification number (SLIN)

9.2.5 Charging process start sequence



1. Authorise the charging process by presenting an RFID card.

⇒ SAM display shows the ID number.



2. Connect the charging cable to the vehicle.

⇒ SAM display shows the charging start, the current consumption and the current duration of charging.

9.2.6 Charging process end sequence



1. End the charging process by presenting the same RFID card or optionally on the vehicle.
 - ⇒ SAM display shows the charging start, the current consumption and the current duration of charging.
2. Disconnect the charging cable from the vehicle.
 - ⇒ SAM display shows the meter and data readings, as well as the consumption of the charge carried out.



9.3 Retrieval of the customer receipt via the document server

The receipt can be retrieved via the following websites:

- ev-beleg.de
- ev-receipt.com
- ev-r.eu



INFORMATION

Retrieval is only possible if a debit/credit card or a virtual card, e.g. via Apple Pay or Google Pay, was used as a payment card.

No registration is required to retrieve receipts.

There are two possible ways to legitimise the receipt.

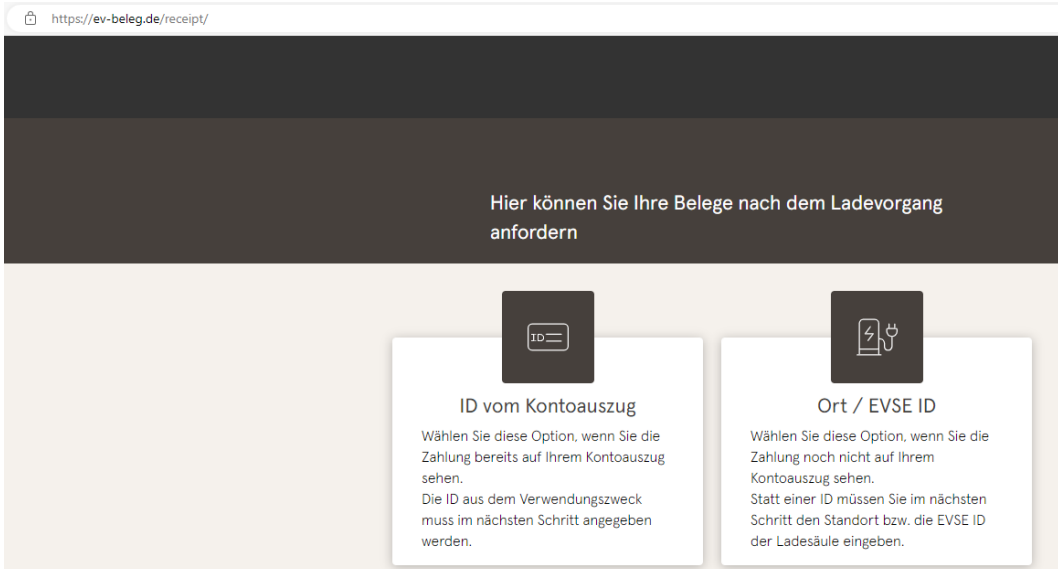

https://ev-beleg.de/receipt/

Hier können Sie Ihre Belege nach dem Ladevorgang anfordern

ID vom Kontoauszug

Wählen Sie diese Option, wenn Sie die Zahlung bereits auf Ihrem Kontoauszug sehen.
Die ID aus dem Verwendungszweck muss im nächsten Schritt angegeben werden.

Ort / EVSE ID

Wählen Sie diese Option, wenn Sie die Zahlung noch nicht auf Ihrem Kontoauszug sehen.
Statt einer ID müssen Sie im nächsten Schritt den Standort bzw. die EVSE ID der Ladesäule eingeben.

Hier können Sie Ihre Belege nach dem Ladevorgang anfordern

ID vom Kontoauszug Ort / EVSE ID

EVSE-ID der Ladesäule oder Ort *

Tag Ihrer Ladung *

Letzten 4 Ziffern Ihrer Zahlungsart eingeben

Senden

Legitimation via the location of the charging station

The following data is required to receive the digital receipt via the location:

- Location of the charging station or the EVSE ID of the charging station
- Day of charging
- The last 4 digits of the payment card used

Hier können Sie Ihre Belege nach dem Ladevorgang anfordern

ID vom Kontoauszug Ort / EVSE ID

ID vom Kontoauszug *

Tag der Buchung *

Letzten 4 Ziffern Ihrer Zahlungsart eingeben

Senden

Legitimation via the ID from bank statement

The following data is required to receive the digital receipt via the ID of the bank statement:

- ID from bank statement/credit card statement
- Day of charging
- The last 4 digits of the payment card used



INFORMATION

If there are several receipts under the first three points, a further point for entering the total price is displayed in order to obtain the appropriate receipt.

Belege für den 08.07.2022

Ihre Belege

Es wurden folgende Belege gefunden

Beleg 08.07.2022 07:50

Oberste-Wilms-Straße 15a
44309 Dortmund

- ✓ Messwerte sind eichrechtskonform erfasst
- ✓ Die eichrechtskonforme Validierung des Ladevorgangs ist lokal an der Ladestation möglich.



By confirming the "Search" button, all receipts matching the selection are called up.

The receipt can then be downloaded using the "Download" button.

```

Oberste-Wilms-Straße 15a
44309 Dortmund

USt.-IdNr.                DE123456789

Ladestation                LP2
Ort                        Dortmund
EVSE-ID:
DE*WLB*12345678901234567890123456789

----- Ladevorgang -----
Nr.                        12345
Startzeitpunkt            21.03.22 16:31
Endzeitpunkt              21.03.22 20:55
Zeit                       264 Min
Startzählerstand          11,699*kWh
Endzählerstand            12,738*kWh

----- Einmalgebühr -----
Preis pro Vorgang         1,00 EUR
----- Energiegebühr -----
Preis pro kWh              0,40 EUR
Geladene Energie          1,039*kWh
----- Parkgebühr -----
Preis pro Minute           0,10 EUR
Parkzeit                   264 Min
----- Blockiergebühr -----
Preis pro Minute           0,10 EUR
Maximale Gebühr           15,00 EUR
Berechnung ab              180 Min
Blockierzeit               84 Min
----- Berechnung -----
1 x 1,00 EUR                1,00 EUR
1,039*kWh x 0,40 EUR        0,42 EUR
264 Min x 0,10 EUR          26,40 EUR
84 Min x 0,10 EUR            8,40 EUR
Summe                      36,22 EUR

MwSt Satz   Netto   MwSt   Brutto
1=19,0%    30,44  5,78   36,22
2=XX,X%    XX,XX  X,XX   XX,XX
Total      30,44  5,78   36,22

Kartenzahlung MasterCard
Terminal ID      45000103
TA-Nr.           000316
Beleg-Nr.        0156
Kartennummer     #####0010
Kontaktlos       Online
VU-Nummer        45560000599
Autorisierungsnummer ---
Autorisierungscode ---

AID              3838393135300000
EMV-Daten:
-----
**                Approved                **

*   Die   Messwerte   wurden
eichrechtskonform   erfasst   Die
    
```

All relevant data according to calibration law is visible on the customer receipt.

9.4 Traceability of payment process/customer (for the CPO of the charging station)

After concluding the contract with the Payment Service Provider (PSP), the operator receives access to the PSP's backend, where the operator can view all transactions with his payment terminal.

Via this portal, the operator can use certain information and consult with the PSP to determine the relevant customer for the transaction. The PSP then takes over communication with the bank in order to clearly identify the customer.

It is therefore possible to draw conclusions about the customer through the traceability of measured values.

The operator can obtain the data for the PSP portal via the receipt:

1. Terminal ID
2. TA-No. (Trace ID)
3. Receipt no.

```

Oberste-Wilms-Strabe 13a
44309 Dortmund

Ust.-IdNr.          DE123456789

Ladestation        LP2
Ort                Dortmund
EVSE-ID:
DE*WLB*12345678901234567890123456789

----- Ladevorgang -----
Nr.                12345
Startzeitpunkt    21.03.22 16:31
Endzeitpunkt      21.03.22 20:55
Zeit              264 Min
Startzählerstand  11,699*kWh
Endzählerstand    12,738*kWh

----- Einmalgebühr -----
Preis pro Vorgang  1,00 EUR
----- Energiegebühr -----
Preis pro kWh     0,40 EUR
Geladene Energie  1,039*kWh
----- Parkgebühr -----
Preis pro Minute  0,10 EUR
Parkzeit         264 Min
----- Blockiergebühr -----
Preis pro Minute  0,10 EUR
Maximale Gebühr  15,00 EUR
Berechnung_ab    180 Min
Blockierzeit     84 Min
----- Berechnung -----
1 x 1,00 EUR      1,00 EUR
1,039*kWh x 0,40 EUR  0,42 EUR
264 Min x 0,10 EUR  26,40 EUR
84 Min x 0,10 EUR  8,40 EUR
Summe            36,22 EUR

MwSt Satz  Netto  MwSt  Brutto
1=19,0%   30,44  5,78  36,22
2=XX,X%   XX,XX  X,XX  XX,XX
Total     30,44  5,78  36,22

Kartenzahlung MasterCard
Terminal ID  45000103
TA-Nr.      000316
Beleg-Nr.   0156
Kartennummer *****0010
Kontaktlos Online
VU-Nummer   455600000599
Autorisierungsnummer ---
Autorisierungscode ---

AID          3838393135300000
EMV-Daten:
-----
**          Approved          **

* Die Messwerte wurden
sicherheitskonform erfasst Die
    
```

Terminal ID 45000103
 TA-Nr. 000316
 Beleg-Nr. 0156

Terminal ID 45000103
 TA-Nr. 000316
 Beleg-Nr. 0156

With this data, the process can be clearly identified via the PSP portal - here using the example of the company Lavego.

TERMINAL-NR.	DATUM	BETRAG	TRANSAKTIONSART	KARTENART	EINGABEMODUS	TRACENR.	BELEG-NR.
52524484	13.07.2022 22:58:58	0,00 €	Kassenschnitt			92	1
52524484	12.07.2022 23:00:00	14,78 €	Kassenschnitt			91	
52524484	15.07.2022 14:35:23	14,78 €	Zahlung TA 7.0		CHN/Chargenkarte	00	20

With this process, the PSP can contact the respective bank with the consent of the operator in order to assign the customer to the payment process and thus also to the metering process that complies with calibration law.

The operator also has the option of filtering out the data record from the storage and display module (SAM) for the customer in accordance with calibration law.

```

----- Berechnung -----
Energiegebühr
3,140 kWh x 0,01 EUR 0,03 EUR A
Nutzungsgebühr
00:04:26 Std x 0,10 EUR 0,44 EUR A
Summe
0,47 EUR

MwSt Satz Netto MwSt Brutto
A=19% 0,08 0,47
Summe 0,08 0,47

Kartenzahlung girocard
ID vom Kontoauszug WXSTPEFI
Terminal ID 52528712
TA-Nr. 000062
Beleg-Nr. 0009
Kartenummer # #####739
Kontaktlos OnLine
VU-Nummer 16693001
Autorisierungsnummer ---
Autorisierungscode ---

AID 3935343835330000
EMV-Daten:

** Approved **
    
```

* Die Messwerte und Tarife wurden eichrechtskonform erfasst.

```

27.06.2022 14:35:29
Start mtr reading: 20,92 kWh
Final mtr readg: 20,93 kWh
Consumption: 0,01 kWh
Start: 27.06.2022 14:34:12
End: 27.06.2022 14:35:23
Duration: 00:01:11
ID: PY2291F221DO18FEF99
TYP2: DE*DC*TYP2
    
```

By filtering out the measurement process from the SAM, traceability to the data for the PSP portal is provided in the data record.

In the ID display in the SAM, the first, eight-digit number group, is the terminal ID (1), which is also listed on the customer receipt, and the second, six-digit number group, is the trace ID (2), which can be used in the PSP portal.

This enables the operator to identify the customer.

10 Language selection

The Charging Point Operator (CPO) has the option of setting a country-specific language for the SAM.



INFORMATION

Basic language

German is always set as the basic language at charging stations that are subject to German calibration law.



Compleo Charging Solutions GmbH & Co. KG

**Ezzestraße 8
44379 Dortmund
Germany**

**info@compleo-cs.com
compleo-charging.com**

©2023 Compleo. All rights reserved.

This document may not be copied or reproduced in any form or by any means, in whole or in part, without written permission. All illustrations in this document serve only as examples and may differ from the delivered product. All information in this document is subject to change without notice and does not represent a commitment on the part of the manufacturer.

Technical changes and errors excepted.



Compleo Charging Solutions GmbH & Co. KG

**Ezzestraße 8
44379 Dortmund
Germany**

**info@compleo-cs.com
compleo-charging.com**

©2023 Compleo. All rights reserved.

This document may not be copied or reproduced in any form or by any means, in whole or in part, without written permission. All illustrations in this document serve only as examples and may differ from the delivered product. All information in this document is subject to change without notice and does not represent a commitment on the part of the manufacturer.

Technical changes and errors excepted.